

# Compendium of Articles on Tether Materials from the ISEC Newsletter

## Table of Contents

- Repairing a Graphene Space Elevator Tether (May 2024)
- How Strong Must a Graphene Tether Material Be? (April 2024)
- Imperfect May Be Good Enough for Graphene Tether Materials (March 2024)
- How Radiation from the Sun Could Affect a Space Elevator Tether (February 2024)
- Could a Space Elevator Tether Burn? (December 2023)
- How 2D Material Laminates Respond to Temperature Changes (November 2023)
- Electrical Conductivity in Graphene Laminates (October 2023)
- Tether Materials Enabling Ultra-high Buildings (September 2023)
- How Ionising Radiation Affects Graphene Super Laminate (August 2023)
- Engaging with the Space Industry and General Public in the UK (July 2023)
- A Graphene Super Laminate Tether May Be More Resilient to Heating than We Thought (June 2023)
- How Tether Materials' Tensile Strength Responds to Temperature (May 2023)
- How Tether Materials Resist Tearing (April 2023)
- Sliding of Layers in Graphene Super Laminate (March 2023)
- Measuring the Friction of Graphene Super Laminate (February 2023)
- International Standards Organisation Standards for Large-area Sheet Graphene (December 2022)
- Snowflake Graphene (November 2022)
- Borophene (October 2022)
- Thinking about How to Prevent Slipping in a Layered Tether (September 2022)
- Graphene Super-laminate (August 2022)
- A New Two-dimensional Material: Graphyne (July 2022)
- Carbon Nanotube / Graphene Yarn (June 2022)
- How Edge Defects Affect the Tensile Strength of Monolayer Graphene (May 2022)
- Carbon Nanotubes and Graphene: Part 2: How We Can Know What We-Know-We-Don't-Know (April 2022)
- Carbon Nanotubes and Graphene (March 2022)

- Quality Control for Large-area Sheet Graphene (February 2022)
- Tether-Climber Interface (December 2021)
- ISEC Visits the Graphene Engineering Innovation Centre (November 2021)
- Industrially Manufactured, Multi-layered, Large-area, Freestanding Sheet Graphene (October 2021)
- Graphene Manufacturing and Costs Trends (September 2021)
- Latest Developments in Manufacturing Graphene (August 2021)
- Fracture Resistance in 2D Materials (July 2021)
- What Would the Tether Look Like? Part 3: More Evidence from a Graphene Heat Spreader (June 2021)
- Space Elevators on Other Planets (May 2021)
- Industrially Manufactured Multi-layered Large-scale Sheet Graphene Samples are Sent to ISEC for Testing (April 2021)
- What Would the Tether Look Like? Part 2: A Tale of Two Tethers (March 2021)
- What Would a Tether Made from 2D Materials Look Like? (December 2020)
- The Graphene Engineering Innovation Centre (March 2020)
- News from the Graphene Engineering Innovation Centre (February 2020)

# Tether Materials (May 2024)

by Adrian Nixon, Board Member, ISEC

## Repairing a Graphene Space Elevator Tether

Dear Reader, you will be familiar with potholes in roads. The term may be a little dramatic when applied to the advanced material of the tether, but you'll understand what we mean.

We can expect a tether in operational use to be subject to wear during its lifetime. An important question is, "Can a tether be repaired?" For the purposes of this article, we will consider a tether made of graphene super laminate (GSL).

As you will know, GSL is made of layers of continuous sheets of graphene stacked as a van der Waals homostructure [1]. Figure 1 shows how this is different from graphite.

### Graphene Super Laminate (GSL) and Graphite



Graphite  
Multi-layered  
graphene nanoplates

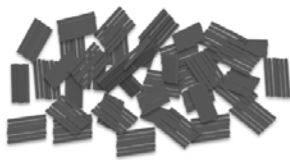

Multilayer graphene exists in nature as graphite  
The bulk material is made of jumbled stacks of nanoplates many thousands of layers thick, each of which is microns or sub-microns in size

Graphene super laminate (GSL)  
Multilayer large-area  
single crystal graphene

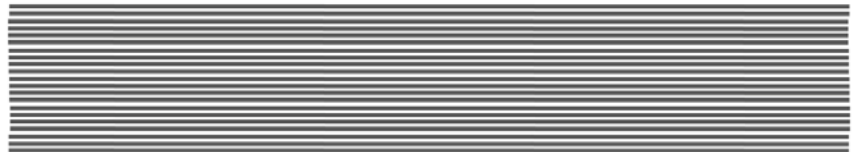

Graphene super laminate is an entirely new material that is not found in nature  
The bulk material will be made of highly coherent layered sheets of single molecules of graphene at scales of  $\text{cm}^2$  and  $\text{m}^2$  and ultimately at kilometre scale

Source:  
Nixon, A., 2021. The graphene and graphite landscape: Indications of unexplored territory. *Nixene Journal*, 5(10), pp.9-20

Figure 1. Graphene super laminate (GSL) and graphite

Regular readers will know that large-area graphene can already be manufactured at scales of up to a kilometre and at speeds of up to two metres per minute [2]. GSL has not been manufactured at these scales and speeds yet, but this is just a matter of time. This is why we are seriously considering GSL as the prime candidate tether material and thinking ahead about its properties and behaviour in use.

In this case, we are anticipating what damage GSL material might experience and thinking about the potential for repair. We can use data from both graphite and graphene in the academic literature to provide answers to some of these questions.

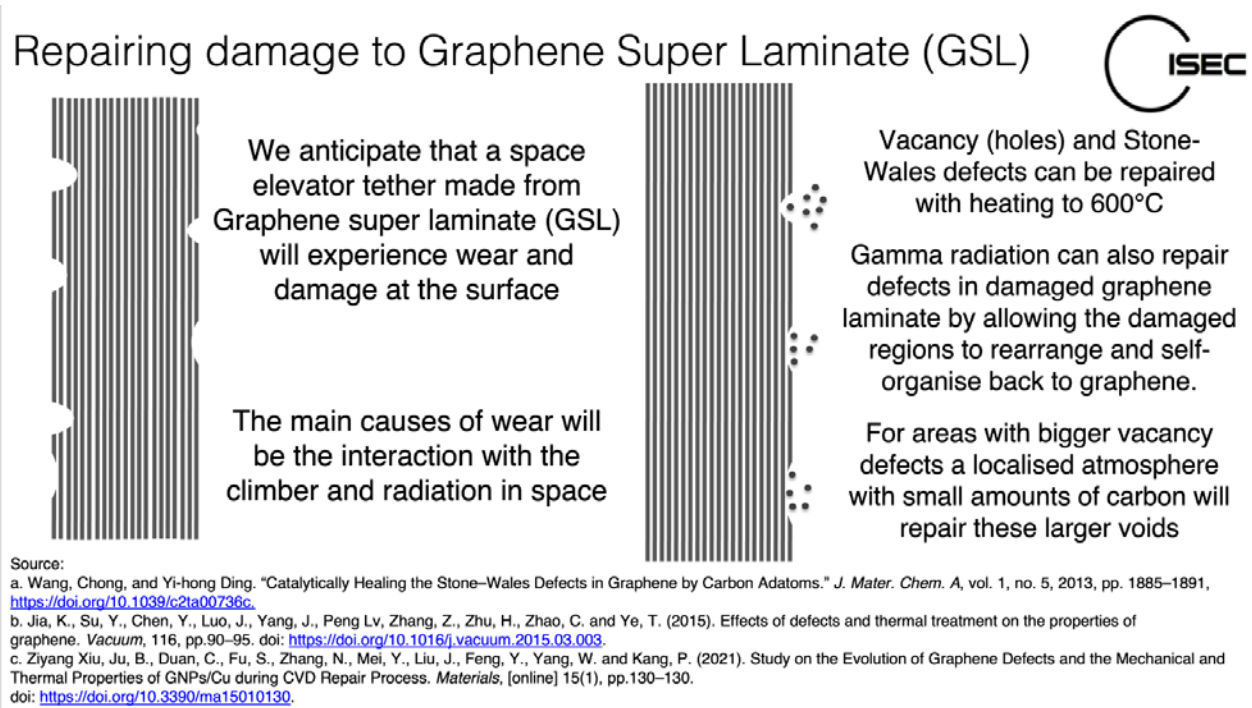

Figure 2. Repairing damage to graphene super laminate

The literature tells us that graphene monolayers and laminate structures have the capacity to self-heal where the damage is small. Heating the damaged area up to 600°C with an inert gas such as argon can allow the carbon atoms in both graphene and graphite to rearrange [3,4].

Similarly, a dose of gamma radiation of 200 kGy can repair defects in damaged graphite by allowing the damaged regions to rearrange and self-organise back to graphene. This means it should be possible to repair damaged regions of GSL with controlled smaller doses of gamma radiation [5].

Where larger holes exist, rearranging existing carbon atoms in GSL might not be sufficient to repair the damage. In this case, a variant of the chemical vapour deposition (CVD) process would provide the necessary carbon atoms to fill the void [6]. Figure 2 above illustrates the process.

To summarise: We can expect a tether made from graphene super laminate to experience damage when in place. The damage will take the form of carbon atoms dislocated from the layered structure. These kinds of defects will self-heal with the application of energy in the form of thermal and ionising radiation. Larger vacancies, (potholes) where the carbon atoms have been removed, can also be repaired with a variant of the chemical vapour deposition process where additional carbon atoms will self-assemble to fill the voids. So, proven mechanisms exist that can be employed to repair a space elevator tether made from graphene super laminate.



## References:

1. Nixon, A., 2021. The graphene and graphite landscape: Indications of unexplored territory. *Nixene Journal*, 5(10), pp.9-20
  2. Nixon, A. (2021). 2021 August International Space Elevator Consortium Newsletter. [online] International Space Elevator Consortium. Available at: <https://www.isec.org/space-elevator-newsletter-2021-august/#tether>.
  3. Wang, Chong, and Yi-hong Ding. "Catalytically Healing the Stone–Wales Defects in Graphene by Carbon Adatoms." *J. Mater. Chem. A*, vol. 1, no. 5, 2013, pp. 1885–1891, <https://doi.org/10.1039/c2ta00736c>.
  4. Jia, K., Su, Y., Chen, Y., Luo, J., Yang, J., Peng Lv, Zhang, Z., Zhu, H., Zhao, C. and Ye, T. (2015). Effects of defects and thermal treatment on the properties of graphene. *Vacuum*, 116, pp.90–95. doi: <https://doi.org/10.1016/j.vacuum.2015.03.003>.
  5. Cataldo, F. (2000). A Raman study on radiation-damaged graphite by  $\gamma$ -rays. *Carbon*, 38(4), pp.634–636. doi: [https://doi.org/10.1016/s0008-6223\(00\)00007-5](https://doi.org/10.1016/s0008-6223(00)00007-5).
  6. Ziyang Xiu, Ju, B., Duan, C., Fu, S., Zhang, N., Mei, Y., Liu, J., Feng, Y., Yang, W. and Kang, P. (2021). Study on the Evolution of Graphene Defects and the Mechanical and Thermal Properties of GNPs/Cu during CVD Repair Process. *Materials*, [online] 15(1), pp.130–130. doi: <https://doi.org/10.3390/ma15010130>.
-

# Tether Materials (April 2022)

by Adrian Nixon and Peter Robinson, ISEC

## How Strong Must a Graphene Tether Material Be?

In the previous newsletter article [1], we explored the strength of polycrystalline graphene. We found that, provided the material is "well stitched together," it has a much higher tensile strength than would be expected: between 90 and 99 GPa.

The current assumption is that a tether material must be incredibly strong over vast distances with a consistent tensile strength with a target of 100 GPa. This strength value is based on the work by Dr. Bradley Edwards for the NASA feasibility study that reported in 2003 [2].

Single crystal graphene is the term for graphene with no defects. It has a tensile strength of 130 GPa and has been made at metre scale in the laboratory [3]. However, we must assume that industrial scale manufacturing processes could make polycrystalline graphene that has a slightly lower tensile strength.

*I asked my colleague Peter Robinson, "How critical is the 100GPa value for tensile strength?"*

*Peter replied...*

The tensile strength of the tether material directly impacts the mass of the tether, and there are practical limits to how great that mass can be for early space elevators. Very simply, establishing the overall mass (and thus strength) needed by a tether depends on the answers to just two questions:

**(a) how much weight does the tether need to support?**

**(b) how strong is the tether material?**

Neither of these questions can be answered definitively yet and will require detailed knowledge of several technical design solutions.

Addressing **question (a)**, the "supported weight," the tether must of course support its own weight, but it must additionally support the weight of whatever climbers are climbing it. There will also be an additional force (or weight) at the Earth Port required to combat atmospheric wind loading.

It is important to recognise the difference between 'weight' and 'mass': a climber might be 20 tonnes in mass (say), but its "weight" that must be supported on the tether will reduce with altitude as the gravity force reduces and is increasingly offset by centrifugal forces, falling eventually to zero weight at geostationary orbit (GEO), as shown in the plot below.

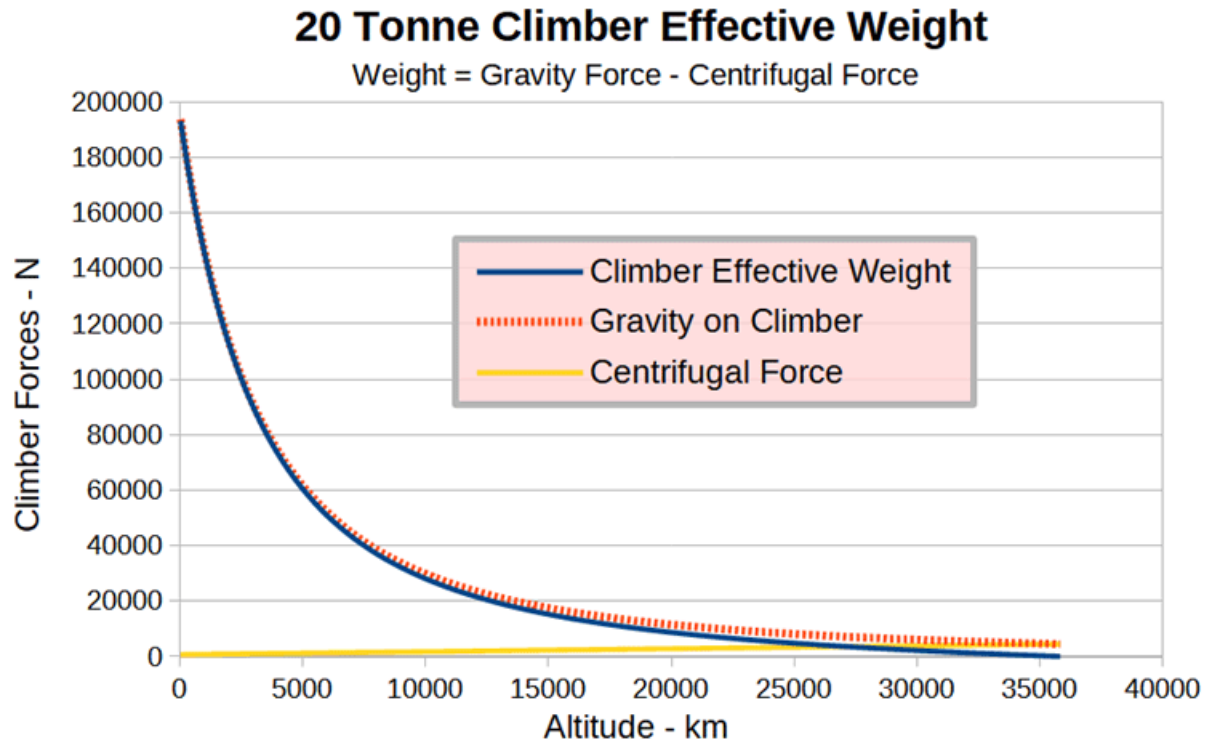

Fig 1. Weight of a 20-tonne climber between Earth and GEO: plotted by Peter Robinson

This is not the whole story: the tether must be designed to support the weight of multiple climbers, so the distribution of the climbers along the tether must be known, as well.

The climber positioning along the tether will depend on parameters such as departure frequency from Earth, maximum drive power and maximum speed. The histogram below shows the worse-case weight that must be supported by the tether for 20 tonne climbers departing daily with 4 MW maximum drive power and maximum speeds of 100 kph and 200 kph.

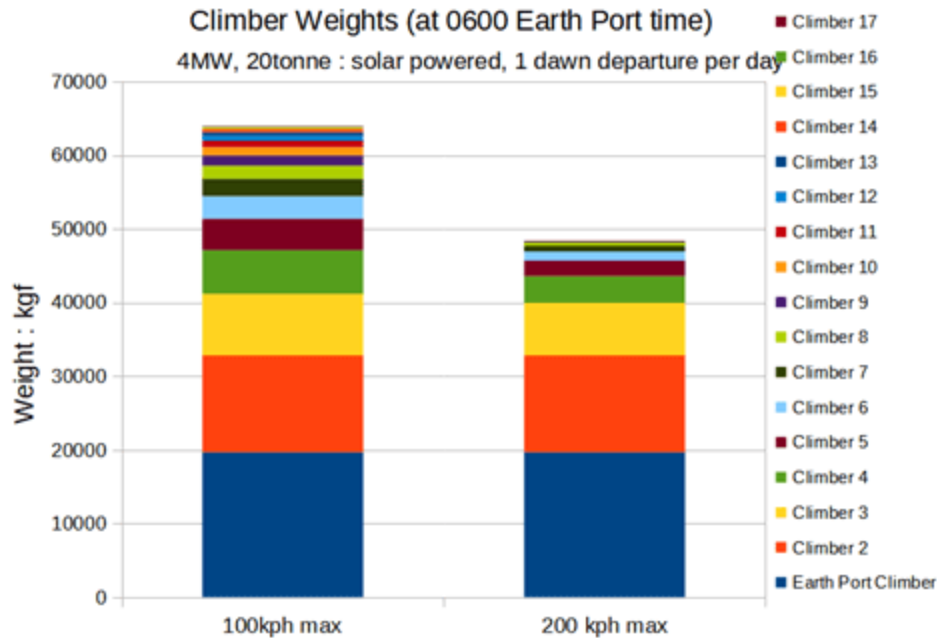

Fig.2 Weight of multiple 20 tonne climbers. Distribution calculated by Peter Robinson in analysis reported in Ref 4, assuming solar power only, 4MW maximum drive power, speed limited by other parameters at higher altitudes.

Thus, slower climbers mean more weight must be supported by the tether, so the tether must be stronger. The discussion of climber design is outside the scope of this article, but this highlights how any necessary tether strength estimate must use assumptions for climber performance and operational factors.

**Question (b)**, the required tether material strength, can be addressed once a tether loading is assumed.

The reader should first understand the concept of “tether taper.” Any part of the tether (below GEO) must support the weight of the tether below it, and this weight will increase with altitude. Thus, the necessary tether strength, or cross-sectional area, will increase with altitude. The “taper ratio” is the ratio of the area at GEO to the area at the Earth, the equation for which was first derived by Jerome Pearson in 1975 (Ref 5).

### Material strength: The Yuri

The measure of material strength that determines the taper ratio is the specific strength (or specific stress), defined as a material stress divided by the material density: Pearson’s equation shows that the taper ratio will be lower for tether materials with higher specific strengths (Ref 6).

The next question is: what material stress should be used to determine the taper ratio, and hence the tether mass and overall strength? The material yield or ultimate tensile stress will be known from laboratory tests and must be confirmed on material mass-produced using the intended large-scale

manufacturing process, but the tether should not be designed to operate close to either its yield or failure stress. Some safety margin is needed to prevent failures under operational and feasible extreme conditions (such as debris damage.) Margins in the range of 40-50% or more have been assumed in some work but must be confirmed by detailed safety studies.

Numerical analysis based on the techniques described in Ref 4 can derive the total required tether mass based on several (arbitrary) design parameters, including tether length (100,000km), climber mass (20t), climber departure frequency (1/day), climber max drive power (4MW) and climber max speed (235 kph, chosen to yield 7-day ascent time to GEO). The plot below shows the total Tether and Anchor masses for a range of working specific strengths.

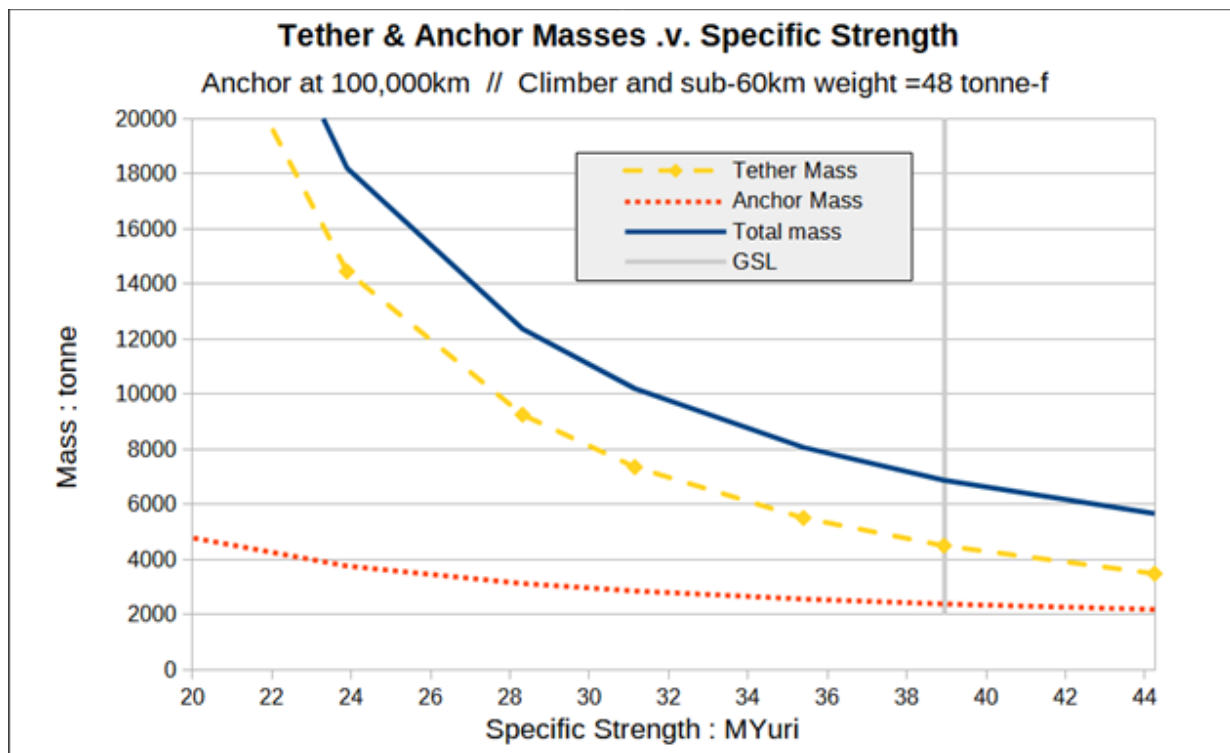

Fig 3. Plot by Peter Robinson based on numerical analysis technique described in Ref 4

This analysis shows that a working stress of 38.9 MYuri (89.4 GPa with 2298.5 kg/m<sup>3</sup> density) would result in a tether mass of 4,492 tonnes, with a cross-sectional area rising from 7 mm<sup>2</sup> at the Earth to 23.7 mm<sup>2</sup> at GEO. This refers to the vertical grey line in Fig 3. Lower specific strengths will require a greater material mass, soon rising to excessive levels. For example, with a 50% reduction to 19.5 MYuri the mass would be 26,608 tonnes, with a cross-sectional area rising from 14.1 mm<sup>2</sup> at the Earth to 163 mm<sup>2</sup> at GEO.

Until macro-scale material samples are fully tested we cannot be certain what specific operating strength can be used, but a value in excess of 30 MYuri may be needed to limit the tether mass to levels that practically could be launched from the Earth. If the tether could be manufactured in space using

ISRU (perhaps using lunar or asteroid material) then it may be possible to use a lower specific strength, but that's for another newsletter.

The thickness of the tether will of course depend on the cross-sectional area and the width. Earlier work has assumed a width of 1m, which means a thickness of 7 microns for an area of 7 mm<sup>2</sup>, corresponding in turn to 20,000 layers, rising by several times at GEO.

There has been much debate on the optimum tether dimensional profile: whether it becomes wider or thicker with altitude will depend on many factors, including manufacturing and climber design issues, but that discussion must also be postponed for a later newsletter.

See the 2023 JBIS paper by Dennis Wright (Ref 6) for a more thorough and scholarly explanation of some of the above.

*...Quite a comprehensive reply from Peter*

To summarise: The answer to the question posed at the beginning shows that the 100 GPa tensile strength value is not a fixed cut off point for a tether material. The actual tensile strength needed depends on an interaction between various engineering design parameters. In essence, the stronger the material is, the less of it we will need.

It should be possible to design and manufacture a tether using graphene with a tensile strength in excess of 90 GPa. This means that imperfect, polycrystalline multilayer graphene should be more than capable of being used as an operating space elevator tether material.

#### **References:**

1. Nixon, A. and Wright, D. (2024). International Space Elevator Consortium Newsletter 2024 March. [online] International Space Elevator Consortium. Available at: <https://www.isec.org/space-elevator-newsletter-2024-march/#tether> [Accessed 18 Mar. 2024].
2. B. Edwards, 2003. The Space Elevator NIAC Phase II Final Report. [online] Atlanta, GA: NASA Institute of Advanced Concepts (NIAC). Available at: [http://www.niac.usra.edu/files/studies/final\\_report/521Edwards.pdf](http://www.niac.usra.edu/files/studies/final_report/521Edwards.pdf) [Accessed 25 February 2024].
3. Xu, X., Zhang, Z., Dong, J., Yi, D., Niu, J., Wu, M., Lin, L., Yin, R., Li, M., Zhou, J., Wang, S., Sun, J., Duan, X., Feng, Y., Jiang, Y., Wu, X., Peng, L.-M., Ruoff, R.S., Liu, Z. and Yu, D. (2017). Ultrafast epitaxial growth of metre-sized single-crystal graphene on industrial Cu foil. Science Bulletin, 62(15), pp.1074–1080. doi: <https://doi.org/10.1016/j.scib.2017.07.005>.
4. Robinson, P. (2023). Space elevator climber dynamics analysis and climb frequency optimisation. Acta Astronautica, 210, pp.518–528. doi: <https://doi.org/10.1016/j.actaastro.2023.04.021>.
5. Pearson, J. (1975). The orbital tower: A spacecraft launcher using the Earth's rotational energy. Acta Astronautica, [online] 2(9-10), pp.785–799. doi: [https://doi.org/10.1016/0094-5765\(75\)90021-1](https://doi.org/10.1016/0094-5765(75)90021-1).

6. Wright, D (2023). Building the Space Elevator Tether. JBIS Volume 76 Issue 7 Pages 225-231  
<https://www.isec.org/s/JBIS-2-Building-the-Space-Elevator-Tether.pdf>

### **Editor's Note: The Yuri**

In the above article Peter uses the unit 'Yuri' for Specific Strength (or Specific Stress). This unit name was coined over ten years ago by Ben Shelef in tribute to Space Elevator co-inventor Yuri Artsutanov (1929-2019) and is now extensively used in Space Elevator circles. MYuri is said as "mega Yuri."

Specific Stress is defined as Stress/Density, meaning that  $1 \text{ Yuri} = 1 \text{ Pa}/(\text{kg}/\text{m}^3) = 1 \text{ Pa}\cdot\text{m}^3/\text{kg}$ . Values are usually quoted in MYuri (=  $10^6$  Yuris), so for material values with typical orders of magnitude,  $1 \text{ MYuri} = 1 \text{ GPa} / (1000 \text{ kg}\cdot\text{m}^3)$ .

DIMENSIONAL ANALYSIS FUN FACT: Specific Strength can also be thought of the Energy per unit mass, or  $E/m$ .

As  $1 \text{ Pa} = 1 \text{ N}/\text{m}^2$  and  $1 \text{ N} = 1 \text{ kg}\cdot\text{m}/\text{s}^2$  the units simplify to  $1 \text{ Yuri} = 1 \text{ m}^2/\text{s}^2$ , which is a velocity squared. Thus  $E/m=v^2$ , or  $E=mv^2$  ... does that look familiar?

---

# Tether Materials (March 2024)

by Adrian Nixon and Dennis Wright, Board Members, ISEC

## Imperfect May Be Good Enough for Graphene Tether Materials

The tether is a critical element of the space elevator. It must be incredibly strong over vast distances with a consistent tensile strength with a target of 100 GPa [1]. We know that graphene has the required combination of tensile strength and mass density to make the tether a reality. The 130 GPa tensile strength we often quote refers to single-crystal graphene.

More people are paying attention to our messaging about tether quality materials, and we are being challenged in new ways. The latest challenge was from a person with considerable industrial manufacturing experience who asked: "Given that industrial processes rarely produce perfect materials, can imperfect graphene be made good enough to do the job of a tether material?"

It was a good question because we know imperfect (polycrystalline) graphene is less strong than perfect single-crystal graphene. However, to quantify this we needed to research the literature.

Fortunately, the work has been done by an international team with members in South Korea and the USA [2]. The team prepared samples of sheet graphene using the chemical vapour deposition (CVD) process. Using electron microscopy, they characterized the graphene as polycrystalline with grain boundaries but no vacancy defects. They called this material 'well-stitched'.

Then they transferred the graphene sheet to a surface containing multiple small holes, or wells. This suspended the graphene over the holes allowing an atomic force microscope to probe the graphene until it punctured. By measuring the force required the team could determine the tensile strength of the material.

They developed this method to measure the strength of single-crystal (pristine) graphene and found a tensile strength of 130 GPa which agreed with the theoretical predictions [3]. This means the test is a reliable indicator of the strength of graphene samples.

When the team tested the well-stitched polycrystalline graphene, they found its tensile strength was very high, between 90 and 99 GPa.



# Single crystal and polycrystalline graphene tensile strength testing

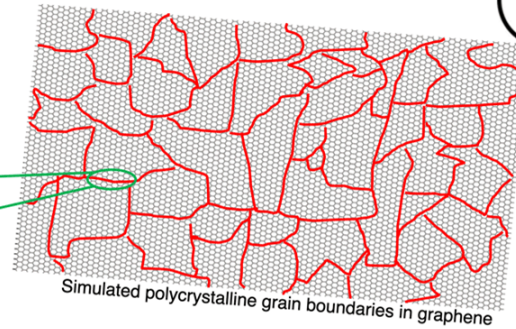
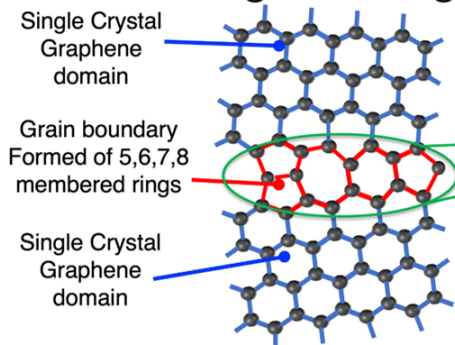

Polycrystalline graphene made by the chemical vapour deposition (CVD) method has been tested in the laboratory and found to have strength close to that of single crystal graphene

Material	Tensile strength GPa
Single crystal graphene with no grain boundary defects	130
Polycrystalline graphene made by the chemical vapour deposition (CVD) method	90 to 99

Source:  
Lee, G.-H. ., Cooper, R.C., An, S.J., Lee, S., van der Zande, A., Petrone, N., Hammerberg, A.G., Lee, C., Crawford, B., Oliver, W., Kysar, J.W. and Hone, J. (2013). High-Strength Chemical-Vapor-Deposited Graphene and Grain Boundaries. *Science*, 340(6136), pp.1073–1076. doi:<https://doi.org/10.1126/science.1235126>.

Industrial scale manufacturing methods are likely to produce polycrystalline rather than perfect single crystal graphene at the scales and speeds needed to manufacture space elevator tether.

This work shows that provided the material has crystal grain boundaries that are well-stitched and have few defects, the current manufacturing methods can make graphene that is strong enough to make a space elevator tether.

## References:

1. B. Edwards, 2003. The Space Elevator NIAC Phase II Final Report. [online] Atlanta, GA: NASA Institute of Advanced Concepts (NIAC). Available at: [http://www.niac.usra.edu/files/studies/final\\_report/521Edwards.pdf](http://www.niac.usra.edu/files/studies/final_report/521Edwards.pdf) [Accessed 25 February 2024].
2. Lee, G.-H. ., Cooper, R.C., An, S.J., Lee, S., van der Zande, A., Petrone, N., Hammerberg, A.G., Lee, C., Crawford, B., Oliver, W., Kysar, J.W. and Hone, J. (2013). High-Strength Chemical-Vapor-Deposited Graphene and Grain Boundaries. *Science*, 340(6136), pp.1073–1076. doi: <https://doi.org/10.1126/science.1235126>.
3. Lee, C., Wei, X., Kysar, J.W. and Hone, J. (2008). Measurement of the Elastic Properties and Intrinsic Strength of Monolayer Graphene. *Science*, [online] 321(5887), pp.385–388. doi: <https://doi.org/10.1126/science.1157996>.

# Tether Materials (February 2024)

by Adrian Nixon, Board Member, ISEC

## How Radiation from the Sun Could Affect a Space Elevator Tether

I was invited to a discussion on LinkedIn to answer a question about how radiation from the Sun would affect a space elevator tether. Dear Reader, it occurred to me that you might find this of interest too, hence this newsletter article that explores the topic in more detail than the discussion thread. We will consider a tether made from Graphene Super Laminate (GSL) or carbon nanotubes (CNTs).

In the discussion thread, we referred to electromagnetic radiation. As you will know, radiation from the Sun has more variety than this....



Image created by AI using the prompt "Sunlight reflected from a space elevator tether above the Earth."

The United States Nuclear Regulatory Commission (USNRC) defines four types of radiation, alpha, beta, neutrons, and electromagnetic waves [1].

Solar radiation is predominantly electromagnetic at the surface of the Earth; however, in space energetic alpha and beta particles and neutrons are also present [2].

**Alpha radiation:** (I'll include protons and neutrons here)

Protons and neutrons are the components of the atomic nucleus. The Sun emits them singly or as pairs of protons and neutrons that comprise the nucleus of the helium atom. NASA also identifies galactic cosmic rays that come from supernovae beyond the solar system and can be the atomic nuclei of any atom in the periodic table moving at incredibly high speeds [2].

A variety of atomic nuclei will therefore collide with the tether causing localised atomic level damage. These collisions can eject electrons from the atoms in the tether causing localised ionisation and breaking of bonds. Provided the bond breaking is at the atomic level it is probable that these broken bonds will spontaneously heal as the ionised atoms are very reactive. Larger holes may remain as localised vacancies and these could reduce the strength of individual layers within the tether.

These collisions will also cause the tether to heat up. Graphene and carbon nanotubes have very high melting points and are excellent conductors of heat, so this is unlikely to affect the integrity of the tether. For more information about the effect of heat on a GSL tether please refer to a previous newsletter article in the references section [3].

A much rarer event could be transmutation. This is where a neutron or a proton collide with and change the structure of the nucleus. Neutron transmutation could create either carbon-13 or carbon-14. This is unlikely to affect the strength of the tether. Proton transmutation would be even rarer (references for this in the literature are hard to find.)

**Beta radiation:** Defined by NASA as electrons and positrons [2].

Most beta particles are very lightweight compared to the carbon atoms in GSL or CNT and will probably bounce off the material. However, very energetic particles will penetrate the structure. Electrons or positrons that penetrate the tether material will produce Bremsstrahlung radiation (braking radiation) [4]. The kinetic energy of the particle is converted into electromagnetic radiation. The higher the energy of the particle, the shorter the wavelength.

A study at the University of Leeds (UK) on nuclear-grade graphite found that the amount of sp<sup>2</sup> hybridised carbon (graphene) was reduced by intense electron bombardment. The authors suspected but did not prove that amorphous carbon was being formed [5]. So, beta radiation must be of extreme intensity to cause damage to a tether made from GSL or CNTs. Less intense radiation will probably result in heating up the tether material, and the tether can withstand heating [3].

### **Electromagnetic radiation:**

Electromagnetic radiation is a term that covers a wide range of wavelengths of which a tiny fraction is visible light. Longer wavelengths include everything from red light through infrared to microwaves. At the blue end of the spectrum, there are ultraviolet, X-rays, and gamma radiation.

At the red end of the spectrum, graphene tends to be more reflective as the wavelength increases. This reflection will protect the tether. At the blue end of the spectrum and beyond, the shorter wavelengths penetrate most materials including graphene and carbon nanotubes. As the wavelength becomes shorter it has enough energy to remove tightly bound electrons from the orbit of an atom, breaking bonds and causing atoms to become charged or ionised. This is known as ionising radiation. The most extreme form is gamma radiation.

A previous newsletter article explored the effects of ionising radiation on the tether and concluded that damage could be sustained by the tether by changing the sp<sup>2</sup> bonding of graphene and carbon nanotubes to the sp<sup>3</sup> form. However, this depends on the intensity and duration of the irradiation [6].

### **NASA's analysis of the solar wind:**

The solar wind is composed mainly of electrons and protons. Larger alpha particles make up about 8% of the total [7]. The Earth's magnetic field screens out most of the charged particles. This means that inside the magnetosphere a tether will be protected from bombardment by these particles.

However, a space elevator tether is an extremely large structure that will extend beyond the magnetosphere. NASA also points out that where the solar wind meets the magnetosphere these charged particles are deflected like water around the bow of a ship on the side of the Earth facing the Sun. The concentration of alpha and beta radiation at this point is going to need a lot more study to properly understand potential impacts on the tether material.

In summary, the effect of radiation from the Sun on tether materials such as GSL and CNTs depends on the type of radiation and its intensity. A tether has yet to be made, however, we know from laboratory studies that the radiation must be extremely intense to cause significant damage. Our current view is that tether materials will be able to withstand damage from the radiation environment in space. However, we are aware that this is a working hypothesis that will need testing at varying distances from the earth's surface once tether materials start to be manufactured in useful quantities. We also await reliable data on the radiation intensity at various altitudes all the way from the surface of the earth out to 100,000 kilometres. In the meantime, a reasonable assumption can be made that the thicker the tether, the longer it will last.

### **References:**

1. Anon (2020). What Are The Different Types of Radiation? [online] NRC Web. Available at: <https://www.nrc.gov/reading-rm/basic-ref/students/science-101/what-are-different-types-of-radiation.html#>.

2. Anon (2017). Why Space Radiation Matters - NASA. [online] NASA. Available at: <https://www.nasa.gov/missions/analog-field-testing/why-space-radiation-matters/#:~:text=Non%2Dionizing%20versus%20ionizing%20Radiation&text=Examples%20of%20ionizing%20radiation%20include> [Accessed 16 Jan. 2024].
  3. Nixon, A. (2023). International Space Elevator Consortium Newsletter 2023 June: A Graphene Super Laminate Tether may be More Resilient to Heating than We Thought. [online] International Space Elevator Consortium. Available at: <https://www.isec.org/space-elevator-newsletter-2023-june/#tether> [Accessed 16 Jan. 2024].
  4. Anon (2020). Bremsstrahlung. [online] Wikipedia. Available at: <https://en.wikipedia.org/wiki/Bremsstrahlung> [Accessed 16 Jan. 2024].
  5. Mironov, B.E., Freeman, H.M., Brown, A., Hage, F., Scott, A.J., Westwood, A., Jean-Pierre da Costa, Weisbecker, P. and Brydson, R. (2015). Electron irradiation of nuclear graphite studied by transmission electron microscopy and electron energy loss spectroscopy. Carbon, 83, pp.106–117. doi: <https://doi.org/10.1016/j.carbon.2014.11.019>.
  6. Nixon, A. (2023a). International Space Elevator Consortium Newsletter 2023 August. [online] International Space Elevator Consortium. Available at: <https://www.isec.org/space-elevator-newsletter-2023-august/#tether> [Accessed 16 Jan. 2024].
  7. Langford, M. and Holt, J.G. (2023). NASA - Space Radiation Analysis Group (SRAG) Web Site. [online] srag.jsc.nasa.gov. Available at: <https://srag.jsc.nasa.gov/spaceradiation/what/what.cfm#:~:text=The%20solar%20wind%20is%20mainly> [Accessed 17 Jan. 2024].
-



## Tether Materials (December 2023)

by Adrian Nixon, Board Member, ISEC

### Could a Space Elevator Tether Burn?

In our previous newsletter, we explored the way tether materials such as graphene super laminate (GSL) respond to heat. Tether materials will be the strongest and most durable ever created. However, we all know that space is a dangerous business where the unexpected causes dramatic failures.

This thinking prompted a question for our risk analysis: Could a tether catch fire and burn, and if so, what conditions could cause this to happen?



A space elevator tether on fire. Image credit: Adrian Nixon with multiple images from Bing Image Creator.

Graphene and carbon nanotubes are two of the candidate materials that have the necessary strength to make a space elevator tether. Many thousands of continuous layers of graphene or continuous strands of carbon nanotubes would be needed. For the purposes of this article, we'll consider both substances to have similar responses to burning and will focus on graphene because there is more published research on this material.

## Graphene and carbon nanotubes

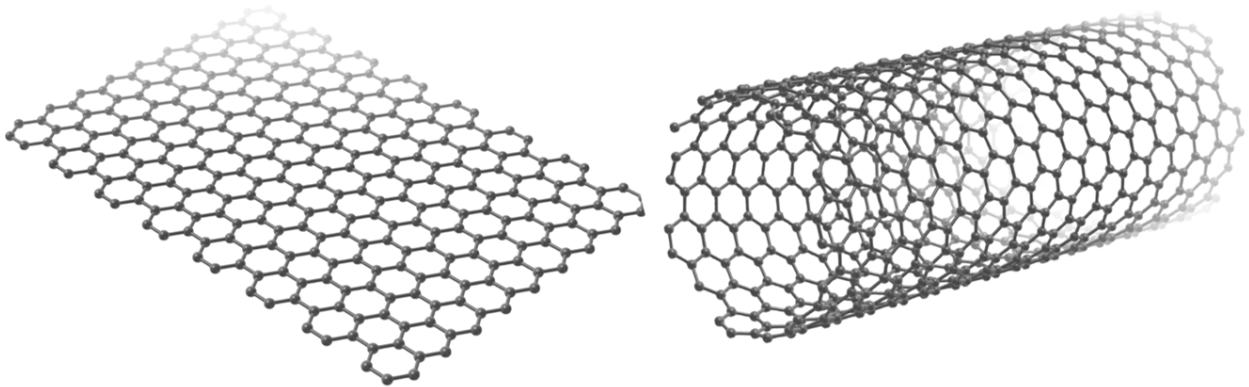

Image credit: Adrian Nixon created using Samson-Core molecular modelling

A tether will be made from multiple layers of single-crystal large-area sheets of graphene called graphene super laminate (GSL). This multilayer graphene is analogous to graphite except in graphite the individual graphene layers are microns in size whereas in GSL they are centimetres, metres, and kilometres in size. This is an important distinction between graphite and GSL.

# How GSL is similar to and different from graphite



Graphite  
Multi-layered  
graphene nanoplates

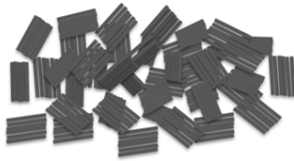

Multilayer graphene exists in nature as graphite  
The bulk material is made of jumbled stacks of nanoplates each of which is microscopic in scale

Graphene super laminate (GSL)  
Multilayer large-area single crystal graphene

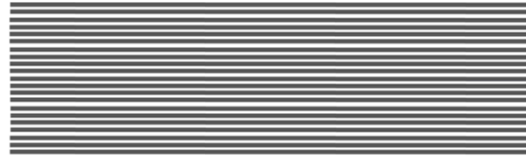

Graphene super laminate is an entirely new material that is not found in nature  
The bulk material will be made of highly coherent layered sheets of single molecules of graphene at scales of  $\text{cm}^2$  and  $\text{m}^2$

Source:  
Nixon. A., 2021. The graphene and graphite landscape: Indications of unexplored territory. *Nixene Journal*, 5(10), pp.9-20

We can derive some indication of the properties of GSL from those of graphite. For example: “graphite was first discovered in Cumbria in North England at the beginning of the sixteenth century. Although it resembled coal, it would not burn” [1].

The performance of GSL will be many times better than graphite because the graphene layers are continuous single crystals of graphene. Chemical reactions in graphene and carbon nanotubes occur at the edges (and vacancy defects). The edges in these materials are where reactions take place, and the basal plane is far less reactive [2]. Burning is a chemical reaction. GSL, having fewer edge sites where reactions can take place will be far more resistant to burning than graphite.

A paper published in 2014 [3], found that the basal plane of monolayer graphene did burn in oxygen at a surprisingly low temperature of  $260^\circ\text{C}$ . However, this required exposure to pure oxygen for five hours. Also, the supporting information for this paper revealed that Chemical Vapor Deposition (CVD) graphene on copper foil was used. The copper being removed with an oxygen plasma and transferred to a support for the testing. This etching and transfer process likely created vacancy defects on the basal plane and these vacancies would act as edges where oxidation could take place.

We also know that graphene resists reacting with oxygen at lower temperatures. Graphene-enhanced carbon fibre composite containers have successfully stored liquid oxygen without degradation [4].

Graphite, graphene, and by implication, carbon nanotubes are quite resistant to burning. This is not to say they will not burn, just that the conditions must be quite extreme. Work done by the Royal Society of Chemistry shows that both diamond and graphite can be made to burn in liquid oxygen by heating



them to red hot and plunging them straight into the cryogenic liquid [5]. The temperature of red-hot graphite is around 800°C [6].

So, could a space elevator tether made from GSL, or ultra-long carbon nanotubes burn? Under nearly all circumstances, no. However, if the tether were to be heated to red hot and then sprayed continuously with liquid oxygen, it just might start burning. So, we can never say never. What we can say is that the risk of a tether being destroyed by fire is a very low probability, but high-impact event for our risk register.

## References

1. Anon (2013). Graphite. [online] Earth Sciences Museum. Available at: <https://uwaterloo.ca/earth-sciences-museum/resources/detailed-rocks-and-minerals-articles/graphite> [Accessed 24 Nov. 2023].
  2. Zahra Komeily-Nia, Qu, L. and Li, J. (2020). Progress in the Understanding and Applications of the Intrinsic Reactivity of Graphene-Based Materials. *Small science*, 1(2), pp.2000026–2000026. Doi: <https://doi.org/10.1002/smsc.202000026>.
  3. Yamada, Y., Kazumasa Murota, Fujita, R., Kim, J., Watanabe, A., Nakamura, M., Sato, S., Hata, K., Ercius, P., Ciston, J., Cheng, S., Kim, K., Regan, W., Gannett, W. and Zettl, A. (2014). Subnanometer Vacancy Defects Introduced on Graphene by Oxygen Gas. *Journal of the American Chemical Society*, 136(6), pp.2232–2235. doi: <https://doi.org/10.1021/ja4117268>.
  4. Francis, S. (2019). Graphene technology enables composite cryogenic pressure vessels. [online] [www.compositesworld.com](http://www.compositesworld.com). Available at: <https://www.compositesworld.com/news/graphene-technology-enables-composite-cryogenic-pressure-vessels> [Accessed 24 Nov. 2023].
  5. Tretiakov, A. (2014). Burning diamond and graphite in liquid oxygen - Video Zoom. [online] MyRSC. Available at: <https://my.rsc.org/video/318> [Accessed 24 Nov. 2023].
  6. Zou, X.P., Abe, H., Shimizu, T., Ando, A., Tokumoto, H., Zhu, S.M. and Zhou, H.S. (2007). Carbon Nanotubes Synthesized by Rapid Quenching of Red-Hot Graphite Rod in Ethyl Alcohol. *Solid State Phenomena*, 121-123, pp.93–96. doi: <https://doi.org/10.4028/www.scientific.net/ssp.121-123.93>.
-

# Tether Materials (November 2023)

by Adrian Nixon, Board Member, ISEC

## How 2D Material Laminates Respond to Temperature Changes

Regular readers will know that the material for the space elevator tether has to be incredibly strong and lightweight. Two-dimensional materials such as graphene and hexagonal boron nitride (hBN) have the necessary qualities that make them candidates for the task. They can be made in monolayers at industrial scales and attention is now being turned to making multilayer (laminates) that will ultimately create the tether.

We already know that two-dimensional (2D) materials have excellent heat conduction properties. Graphene and hBN also have extremely high melting points, both over 3000K. In a previous newsletter, we explored how new materials such as graphene laminates would be structured (Newsletter archive, August 2022). Graphene laminates are made from large area sheets of graphene stacked on top of one another. Stacked layers of hBN can also form laminate structures.

Understanding how heating and cooling affect 2D materials, such as graphene and hBN, will become more important as they are made at larger and larger scales.

### Hexagonal boron nitride and Graphene

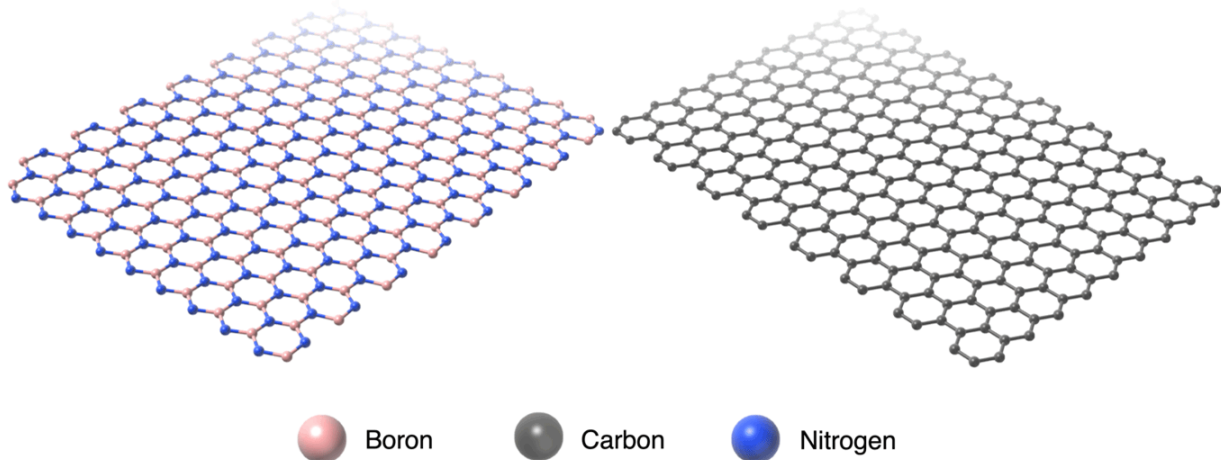

Image credit: Adrian Nixon created using Samson-Core molecular modelling

Most materials expand when heated and contract when cooled. However, this is not the case for all materials. Graphene and hBN are contrary examples, they have negative thermal expansion coefficients, at least for their in-plane behaviour [2,3].

The thermal expansion coefficient (TEC) tells us how much a material expands and contracts with a change in temperature [1]:

$$\Delta L = \alpha \Delta T$$

Where:

$\Delta L$  = The change in length

$\alpha$  = The thermal expansion coefficient

$\Delta T$  = The change in temperature

The TEC can also change with temperature and it is a mistake to think the TEC has a constant value for a given material. However, the following table uses data from peer reviewed sources where the TEC is relatively stable. The calculations will be good enough for the purposes of this article.

Material and temperature range tested	Thermal expansion coefficient (K <sup>-1</sup> )	Change in length due to thermal expansion for 1m with 100K change (m)	% change in length for 100K temperature change (%)	Change in length of 1m long strip for 100K temperature change (mm)	Ref
Graphene at 298K (In-plane)	-3.8 x 10 <sup>-6</sup>	-3.8 x 10 <sup>-4</sup>	-0.038	-0.38	2
hBN at 298K	-2.7 x 10 <sup>-6</sup>	-2.7 x 10 <sup>-4</sup>	-0.027	-0.27	3
hBN at 700 to 1100K (In-plane)	-2.4 x 10 <sup>-6</sup>	-2.4 x 10 <sup>-4</sup>	-0.024	-0.24	
hBN (Constant between 273 to 800K) (Cross-plane)	40.5 x 10 <sup>-6</sup>	40.5 x 10 <sup>-4</sup>	0.405	4.05	3
Aluminium	24 x 10 <sup>-6</sup>	24 x 10 <sup>-4</sup>	0.240	2.4	4
Steel	12 x 10 <sup>-6</sup>	12 x 10 <sup>-4</sup>	0.120	1.2	4

The following graphic shows what is meant by planes in this context:

## Graphene laminate planes

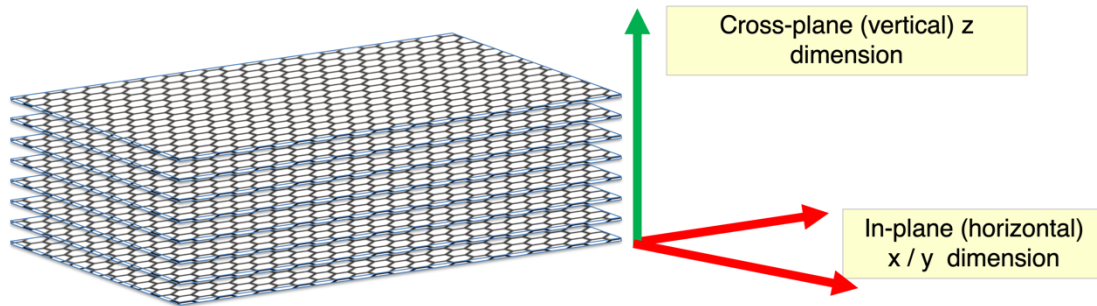

The data shows us that graphene and hBN have negative TEC values in the in-plane dimensions. They both contract slightly with increasing temperature and expand slightly as they are cooled. This difference is small, it is an order of magnitude smaller than for metals such as aluminium and steel (ten times less).

Aluminium and steel are isotropic materials. This means their properties are the same no matter what the plane dimension. Graphene and hBN are layers of 2D materials and this gives them anisotropic properties. They behave differently in-plane to the cross-plane.

The experimental data for hBN shows that the TEC is positive in the cross plane and is about ten times greater. This will probably be similar for graphene although experimental data for this was hard to find. This means that when heated, a bulk material made from layers of hBN will contract very slightly in-plane and expand slightly in the cross plane.

These effects are interesting but for most practical purposes, in temperature ranges from absolute zero to 1000K, they are so slight that we can focus on other physical properties and consider graphene and hBN laminates as essentially thermally stable materials.

However, the scale of a space elevator tether is such that a 0.038% length change for each 100K temp change corresponds to a length change of 38 km for a 100,000km tether. This assumes the temperature change applies all the way along the entire length of the tether. This might not happen if the tether is used purely mechanically as there will probably be regions of relatively hot and cold that would mitigate this overall expansion. If a graphene tether is used to conduct electricity for power distribution then this could heat the tether to the point where the contraction would need to be taken into account in the design of the structure.

## References:

1. Jibson, D. and Wordeman, K. (2023). Steps for Calculating the Change in Length of an Object Due to Thermal Expansion. [online] Study.com. Available at: <https://study.com/skill/learn/how-to-calculate-the-change-in-length-of-an-object-due-to-thermal-expansion-explanation.html>.
  2. McQuade, G.A., Plaut, A.S., Usher, A. and Martin, J. (2021). The thermal expansion coefficient of monolayer, bilayer, and trilayer graphene derived from the strain induced by cooling to cryogenic temperatures. Applied Physics Letters, 118(20), p.203101. doi: <https://doi.org/10.1063/5.0035391>.
  3. Kriegel, M.A., Omambac, K.M., Steffen Franzka, Meyer, F.-J. and M. Horn-von Hoegen (2023). Incommensurability and negative thermal expansion of single layer hexagonal boron nitride. Applied Surface Science, 624, pp.157156–157156. doi: <https://doi.org/10.1016/j.apsusc.2023.157156>.
  4. Anon (2005). Thermal Expansion Coefficients. [online] hyperphysics.phy-astr.gsu.edu. Available at: <http://hyperphysics.phy-astr.gsu.edu/hbase/Tables/thexp.html>.
-

# Tether Materials (October 2023)

by Adrian Nixon, Board Member, ISEC

## Electrical Conductivity in Graphene Laminates

As you will be aware from previous newsletter articles (August 2022 ISEC newsletter) that layers of large-scale sheets of graphene (graphene laminates) are the current best material from which a space elevator tether can be made. The material does not yet exist in large amounts; however, we do know that teams are actively working on this.

Graphene is the world's best conductor of electricity, so could we use a graphene tether to transmit power and data? Comparing graphene and copper is instructive.

Copper is the world's best non-precious metal electrical conductor. Graphene is at least 1.6 times more electrically conductive than copper. This might not sound like much but there is another factor to consider. Materials heat up as they conduct electricity, and this causes the material to fail. This is expressed as the breakdown current density, measured in amps per square metre (A/m<sup>2</sup>). The higher the numbers, the more power the material can transport. Figure 1 shows the comparison of the electrical properties of graphene and copper.

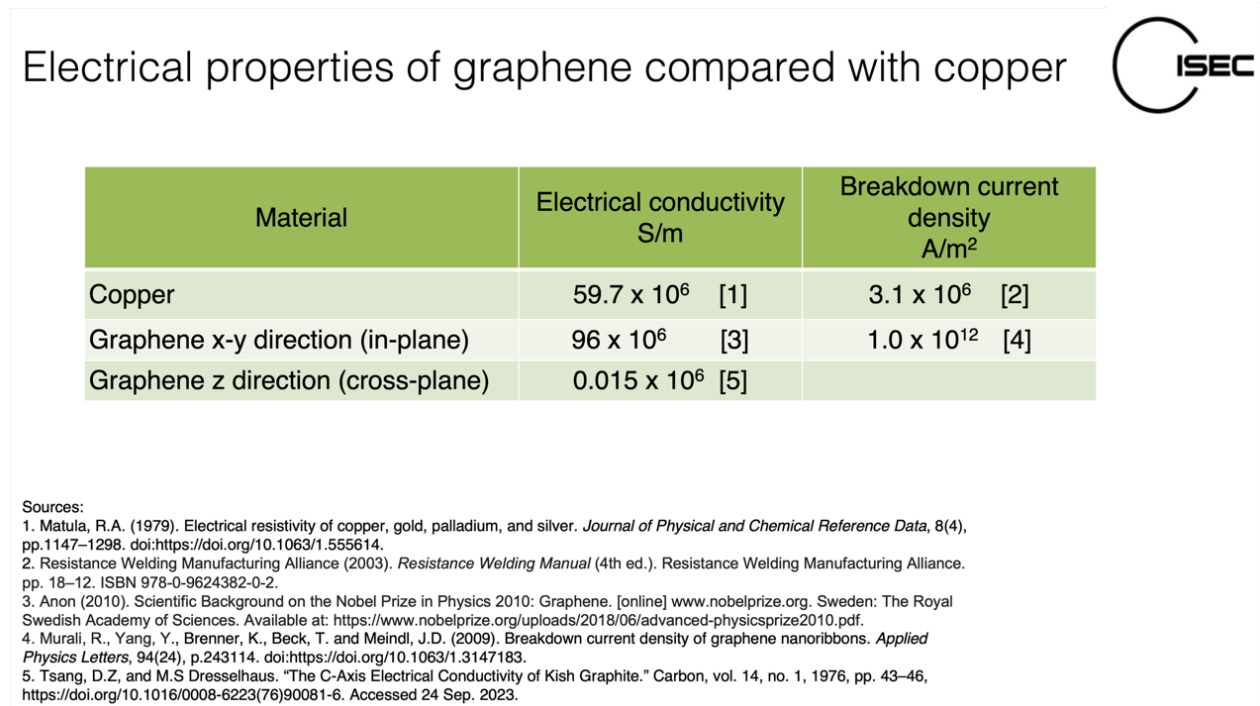

Figure 1. The electrical properties of graphene and copper

Graphene outperforms copper as an electrical conductor. With an electrical conductivity of 96 to copper's 60 mega siemens per metre [1,3], graphene also has one million times the breakdown current

density than copper. This means it can carry orders of magnitude more electric current before burning up [2,4].

A fascinating difference is the way the materials perform when measured in different spatial dimensions. We live in a world of three spatial dimensions, left-right; near-far; up-down, also called x, y, and z directions. Copper has the same properties no matter what the orientation of the material. This is termed isotropic.

Graphene is different. It is a two-dimensional (2D) material, and it performs differently in different dimensions. This is termed anisotropic. In the x/y direction it is highly electrically conductive, yet in the z direction it is 6,400 times less electrically conductive [5]. Figure 2 shows this difference.

## Anisotropic electrical properties of graphene laminate

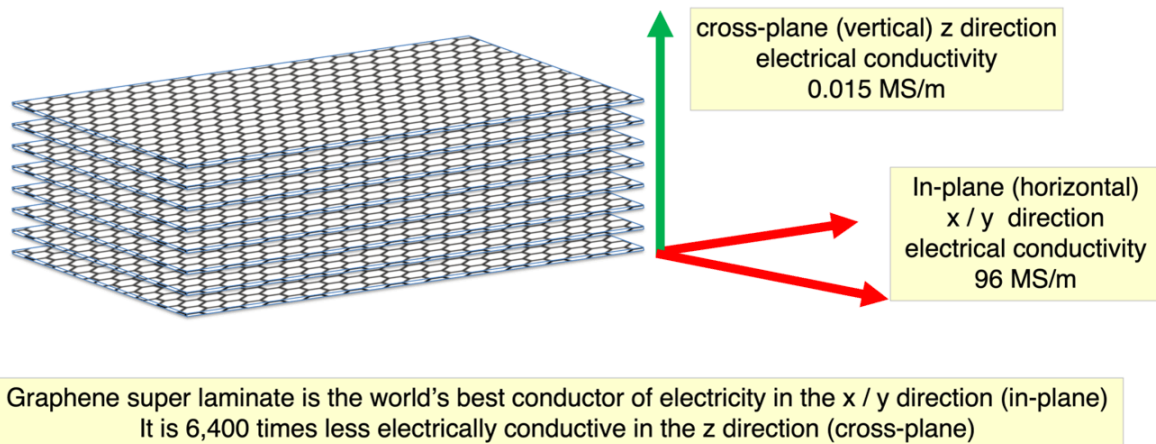

### Sources:

3. Anon (2003). *Resistance welding manual*. 4. ed ed. [online] *K10plus ISBN*, Philadelphia, Pa: RWMA, Resistance Welder Manufacturers' Association, pp.12–18. 978-0-9624382-0-2 [Accessed 24 Sep. 2023].
5. Tsang, D.Z. and M.S Dresselhaus. "The C-Axis Electrical Conductivity of Kish Graphite." *Carbon*, vol. 14, no. 1, 1976, pp. 43–46, [https://doi.org/10.1016/0008-6223\(76\)90081-6](https://doi.org/10.1016/0008-6223(76)90081-6). Accessed 24 Sep. 2023.

Figure 2. The anisotropic electrical properties of graphene laminate

This anisotropy means that a tether made from graphene laminate could perform very well as a power cable. Electrical current injected at one end can be extracted from the other end, or the sides. However, this also means that it will be difficult to extract electrical power from the large exposed flat surface (basal plane). So, powering a moving climber from the tether could be quite a challenge.

We know that to make a tether, teams must work on making graphene in continuous lengths. However, getting funding to do this is proving difficult for companies working in this field because the returns on investment are much longer term than private equity sources are used to supporting. Using graphene wire ribbons for power and data cabling could be a way to gain funding in shorter timescales while developing the technology to make a full-scale tether.



We know that it is possible, in principle, to change the bonding of the carbon atoms in graphene from  $sp^2$ , which is electrically conductive, to  $sp^3$  which is electrically insulating. This opens the possibility of creating long lengths of electrically conductive material with contacts at either end as shown in figure 3.

## A new kind of wire for for electrical power and data transmission: Graphene laminate wire ribbon



Graphene laminate ribbon is made from many thousands of continuous layers of graphene ( $sp^2$ ) in a van der Waals homostructure

Graphene laminate is 1.6 times more electrically conductive four times lighter, and 300 times stronger than copper [a, b]

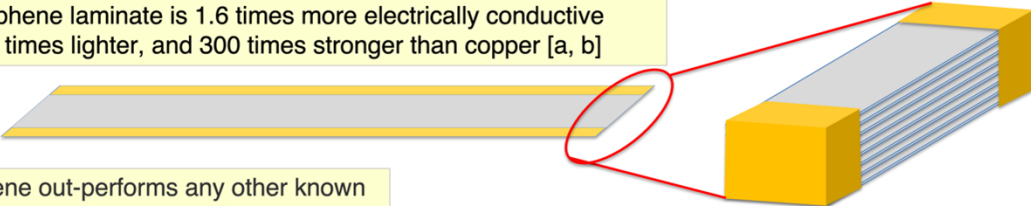

Graphene out-performs any other known material, including superconductors, when carrying high-frequency electrical signals compared to direct current, essentially transmitting signals without any additional energy loss. [6]

Cross section of the graphene laminate wire ribbon  
 $sp^2$  carbon in grey and  $sp^3$  carbon in yellow

$sp^2$  carbon is the world's best conductor of electricity  
 $sp^3$  carbon is an electrical insulator

Sources:

a. mass density  $kg/cm^3$  copper 8940.0 Graphene laminate 2298.5

b. tensile strength MPa Copper 390 Graphene laminate 130,000

6. Awan, S.A., Lombardo, A., Colli, A., Privitera, G., Kulmala, T.S., Kivioja, J., Mikito Koshino and Ferrari, A.C. (2016). Transport conductivity of graphene at RF and microwave frequencies. *2D materials*, 3(1), pp.015010–015010. doi:<https://doi.org/10.1088/2053-1583/3/1/015010>.

Figure 3. Graphene laminate wire ribbon for power and data cabling

Sealing the sides of a graphene wire ribbon could make a very attractive power cable for long distance power transmission. Graphene has a quarter of the mass density of copper. It is also chemically inert in ambient conditions; it won't rot or rust. Graphene has also been found to be an excellent carrier of electrical signals. High frequency currents can be transmitted with almost no energy loss along graphene [6]. This would make graphene laminate wire ribbon very attractive for secure data communications.

There is another reason that graphene laminate wire ribbons would be very attractive soon. We face a dilemma caused by the transition from fossil fuels to a more sustainable energy future. We already need vast amount of copper for the power transmission and data cabling needed for our homes, workplaces, and vehicles.

Consider the Chuquicamata copper mine in Chile. It is one of the largest in the world, 4.5 kilometres long, 3.5 kilometres wide and with a depth of 850 metres (Figure 4). A new book, *Material World: A Substantial Story of Our Past and Future*, points out that to satisfy our future demand for copper, even with recycling, will require three new mines like this every year. The copper reserves exist to meet this need but the environmental impact of extracting this much material will rapidly become socially unacceptable [7].



# Chuquicamata copper mine in Chile

4.5 kilometres long, 3.5 kilometres wide and with a depth of 850 metres

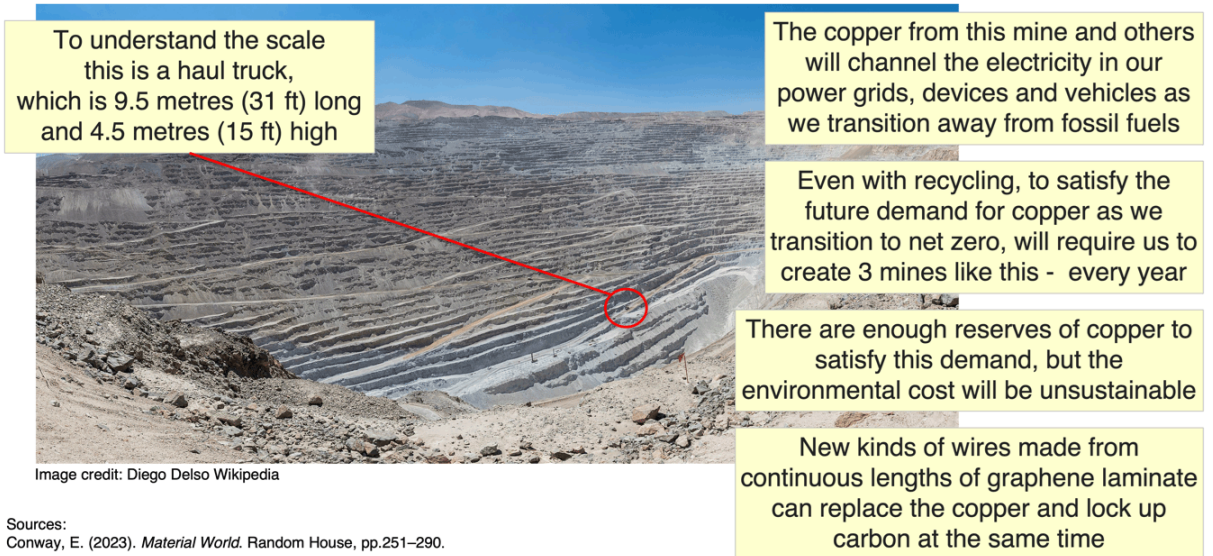

Figure 4. The Chuquicamata copper mine in Chile

Graphene laminate wire ribbons offer a way out of the copper dilemma. Making graphene laminate in continuous lengths uses carbon containing feedstocks and locks up greenhouse gases while making a very useful high technology product.

Making the space elevator a reality will require us to engage with investors with profitable shorter-term solutions that generate returns on investment that funders will support. Making graphene laminate wires could be one of these breakthrough technologies. The manufacturing process for high-capacity power wire ribbons will be the same as that for the space elevator tether.

## References:

1. Matula, R.A. (1979). Electrical resistivity of copper, gold, palladium, and silver. *Journal of Physical and Chemical Reference Data*, 8(4), pp.1147–1298. doi: <https://doi.org/10.1063/1.555614>.
2. Resistance Welding Manufacturing Alliance (2003). *Resistance Welding Manual* (4th ed.). Resistance Welding Manufacturing Alliance. pp. 18–12. ISBN 978-0-9624382-0-2.
3. Anon (2010). Scientific Background on the Nobel Prize in Physics 2010: Graphene. [online] [www.nobelprize.org](http://www.nobelprize.org). Sweden: The Royal Swedish Academy of Sciences. Available at: <https://www.nobelprize.org/uploads/2018/06/advanced-physicsprize2010.pdf>.
4. Murali, R., Yang, Y., Brenner, K., Beck, T. and Meindl, J.D. (2009). Breakdown current density of graphene nanoribbons. *Applied Physics Letters*, 94(24), p.243114. doi: <https://doi.org/10.1063/1.3147183>.

5. Tsang, D.Z, and M.S Dresselhaus. "The C-Axis Electrical Conductivity of Kish Graphite." Carbon, vol. 14, no. 1, 1976, pp. 43–46, [https://doi.org/10.1016/0008-6223\(76\)90081-6](https://doi.org/10.1016/0008-6223(76)90081-6). Accessed 24 Sep. 2023.
  6. Awan, S.A., Lombardo, A., Colli, A., Privitera, G., Kulmala, T.S., Kivioja, J., Mikito Koshino and Ferrari, A.C. (2016). Transport conductivity of graphene at RF and microwave frequencies. 2D materials, 3(1), pp.015010–015010. doi: <https://doi.org/10.1088/2053-1583/3/1/015010>.
  7. Conway, E. (2023). Material World. Random House, pp.251–290.
-

# Tether Materials (September 2023)

by Adrian Nixon, Board Member, ISEC

## Tether Materials Enabling Ultra-high Buildings

There is continual competition around the world to construct the highest skyscraper. At the time of writing the world record holder for the tallest building is the Burj Khalifa in Dubai at 828 metres (2,717 ft) [1]. In Saudi Arabia the Jeddah Tower is planned to be the world's first one-kilometre-high building [2].



Looking down on Dubai skyscrapers from the Burj Khalifa. Image credit: Selim Mohammed, Pixabay.

This raises an intriguing question. How high could a building be built?

William Baker, the top structural engineer at Skidmore, Owings, and Merrill, the firm of architects that designed the Burj Khalifa, was interviewed by Bloomberg about the structural limits of tall buildings. In the interview, a height of around 8,849 metres (5.5 miles high) was estimated to be the technical limit with today's technology [3].

The predominant problem constraining the height of tall buildings is the elevator transport system. Most tall buildings need two or more elevator drops. This means a visitor must change from one elevator to

another halfway up to reach the very top. The reason for this is the limitation of the steel used to make the elevator ropes.

Elevator manufacturer Kone has developed a new carbon fibre material they call Ultra Rope, and this is planned to be used to make a single elevator drop on 1000m for the Jeddah Tower [4].

Reaching the heights of ultra-tall buildings several kilometres high will need technology beyond Ultra Rope. The limitation is the tensile strength of the material. The higher the tensile strength, the higher you can build an elevator.

Elevator steel wire ropes have a tensile strength of 1.77 GPa [5].

Carbon fibre has a tensile strength of up to 7 GPa [6].

This is where graphene comes into play with a tensile strength of 130 GPa [7].

A new elevator technology based on layers of single-crystal graphene could enable the ultra-strong elevators needed for these world record breaking buildings. An elevator material made from 12,333 layers of single-crystal graphene could support an elevator of 20 tonnes for heights of more than 10 kilometres [8].

Finding market applications for graphene technology that enable the next generation of ultra-high skyscrapers will be a useful step along the way to generate a return on investment for graphene tether manufacturers.

A construction application inside tall buildings would help prove the technology and ease construction engineers towards the goal of building the biggest structure of all, the space elevator.

## References:

1. Guinness World Records (2009). Burj Khalifa: The tallest building in the world. [online] Guinness World Records. Available at: <https://www.guinnessworldrecords.com/records/hall-of-fame/burj-khalifa-tallest-building-in-the-world> [Accessed 27 Aug. 2023].
2. Roos, D. (2022). Will the Jeddah Tower, World's Tallest Building, Ever Be Finished? [online] HowStuffWorks. Available at: <https://science.howstuffworks.com/engineering/civil/jeddah-tower.htm> [Accessed 27 Aug. 2023].
3. Berg, N. (2012). Is There a Limit to How Tall Buildings Can Get? [online] www.bloomberg.com. Available at: <https://www.bloomberg.com/news/articles/2012-08-16/is-there-a-limit-to-how-tall-buildings-can-get>. [Accessed 27 Aug. 2023].
4. Barr, J. (2019). Elevator speed - Building the Skyline. [online] buildingtheskyline.org. Available at: <https://buildingtheskyline.org/tag/elevator-speed/> [Accessed 27 Aug. 2023].
5. Anon (2019). ELEVATOR STEEL WIRE ROPES for North America. [online] www.iphglobal.com. Available at: <https://www.iphglobal.com/uploads/downloads/505134001570111159.pdf> [Accessed 27 Aug. 2023].

6. Mirdehghan, S.A. (2021). Fibrous polymeric composites. *Engineered Polymeric Fibrous Materials*, pp.1–58. doi: <https://doi.org/10.1016/b978-0-12-824381-7.00012-3>.

7. Lee, C., Wei, X., Kysar, J.W. and Hone, J. (2008). Measurement of the Elastic Properties and Intrinsic Strength of Monolayer Graphene. *Science*, [online] 321(5887), pp.385–388. doi: <https://doi.org/10.1126/science.1157996>.

8. Nixon, A., Knapman, J. and Wright, D.H. (2023). Space elevator tether materials: An overview of the current candidates. *Acta Astronautica*, [online] 210. doi: <https://doi.org/10.1016/j.actaastro.2023.04.008>.

---



# Tether Materials (August 2023)

by Adrian Nixon, Board Member, ISEC

## How Ionising Radiation Affects Graphene Super Laminate

More people are becoming interested in graphene super laminate (GSL), and this means I'm meeting people from broader backgrounds than just the space community. I was asked a question I didn't know the answer to, so I did some research to fill the gap. This led to interesting answers.

The question was: *How is GSL affected by ionising radiation, in particular, gamma radiation?*

To begin with, we need to understand what is meant by the term ionising radiation.

Ionising radiation is part of the electromagnetic spectrum. It is made of the same stuff as the light we see in a rainbow. We perceive different wavelengths of light as colours of the rainbow. The shorter the wavelength, the bluer the light, and the longer wavelengths we see as greens, yellows, oranges, and reds. The spectrum of light radiation extends far beyond that which our eyes can perceive. Beyond the red end of the spectrum is infrared, microwaves, and radio waves. Graphene does interact with these longer wavelengths. Figure 1 shows the range of wavelengths.

### The electromagnetic spectrum: Highlighting ionising radiation

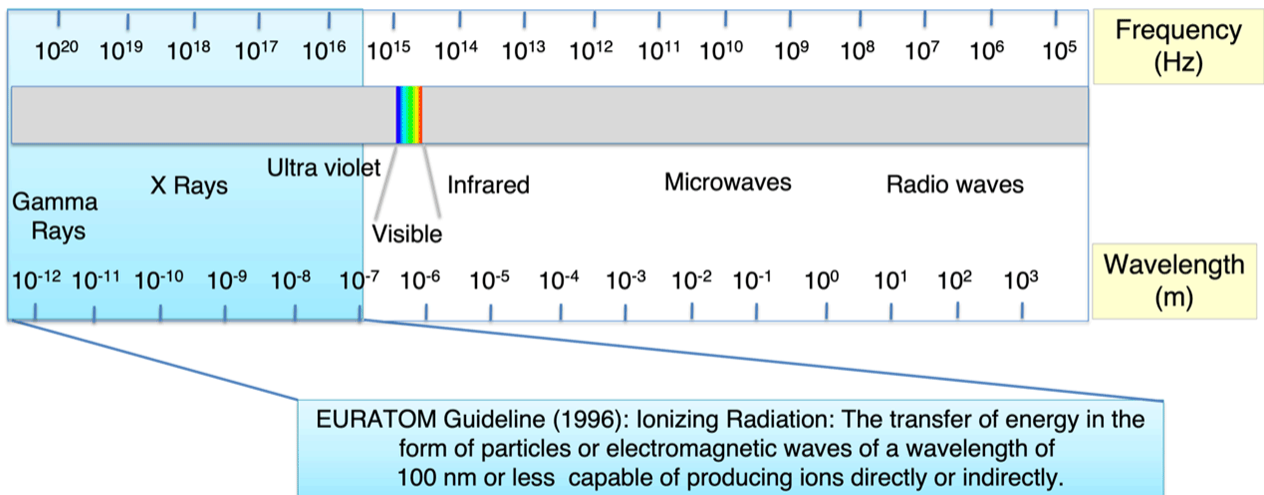

Source:  
Xa9745669, M. and Tschurlovits (1996). IAEA-CN-67/153 i What is 'ionizing radiation'? [online] Available at:  
[https://www.osti.gov/etdweb/servlets/purl/593131#:~:text=EURATOM%20Guideline%20\(1996\)%3A%20Ionizing](https://www.osti.gov/etdweb/servlets/purl/593131#:~:text=EURATOM%20Guideline%20(1996)%3A%20Ionizing) [Accessed 16 Jul. 2023].

Figure 1 The electromagnetic spectrum

Graphene tends to be more reflective at the red end of the spectrum as the wavelength increases. At the blue end of the spectrum and beyond, the shorter wavelengths penetrate most materials, including

graphene. As the wavelength becomes shorter, it has enough energy to remove tightly bound electrons from the orbit of an atom, breaking bonds and causing atoms to become charged or ionised. This is known as ionising radiation. The most extreme form is gamma radiation [1,2].

So, what effect does gamma radiation have on a material such as GSL?

Graphene super laminate is a material made of many layers of graphene held together by van der Waals (VdW) forces, a VdW homostructure. GSL can be dismissed as graphite, however, in graphite the graphene layers are separate stacks several hundred nanometres in size. In GSL, the graphene layers are centimetres, metres, or kilometres in size. When the individual layers of graphene are polycrystalline, we term the bulk material Graphene Laminate (GL). When the graphene layers are single crystals of graphene, we term the material Graphene Super Laminate [3]. Figure 2 shows the difference between the materials.

## Van der Waals homostructures of graphene: How graphene super laminate is different to graphite

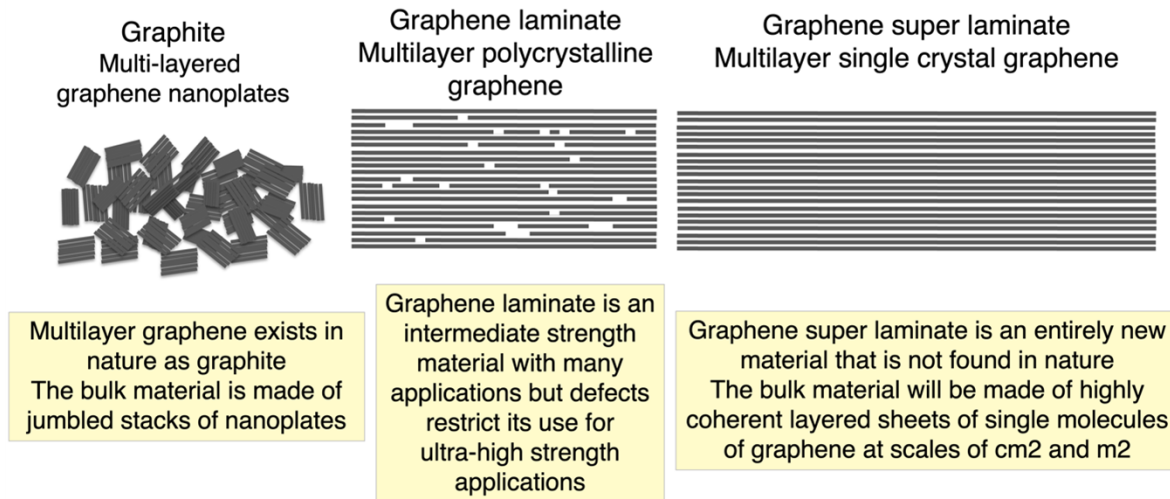

Source:  
Nixon, A., 2021. The graphene and graphite landscape: Indications of unexplored territory. *Nixene Journal*, 5(10), pp.9-20

Figure 2. Graphite and Graphene Super Laminate

Researchers at the Hefei University of Technology in China have investigated what happens to graphite when irradiated with gamma radiation. This gives us a strong indication of how GSL will respond when subjected to the same treatment.

The team placed graphite samples in glass containers and irradiated these in an ambient atmosphere at room temperature. The gamma radiation was generated by the radioactive isotope Cobalt 60 (60Co). This generates gamma-quanta of energy at 1.17 and 1.33 MeV. The dose rate was controlled at 1.8 kGy/h by adjusting the distance between the samples and the 60Co source.

The work produced three findings of interest to us:

- i. The team found that graphite irradiated with a total dose of 2 MGy had more defects than that irradiated with a total dose of 200 kGy [4]. So, very high levels of gamma radiation will damage graphite and, by implication, also damage GSL.
- ii. The team also found that the lower dose of gamma radiation of 200 kGy repaired defects in damaged graphite by allowing the damaged regions to rearrange and self-organise back to graphene. This means it might be possible to repair damaged regions of GSL with controlled smaller doses of gamma radiation.
- iii. The team also noted another study that gamma radiation under nitrogen, at room temperature, with a total dose of 1 MGy at a rate of 5.7 kGy/h, could produce significant damage in graphite. The radiation formed domains of hexagonal diamond (Lonsdaleite), amorphous glassy carbon, and onion-like carbon [5]. This is very interesting because “damage” in this context means forming crosslinks between the graphene layers, and this could be a new method of “spot welding” the graphene layers reducing slippage in a tether made from GSL.

This all means that we need to be mindful of very high levels of gamma radiation in the order of mega Grays (MGy), causing damage to structures made of GSL. Their short wavelength means they will penetrate the graphene layers and potentially affect the material at a range of depths.

The radiation dose in space has been measured by NASA on the Apollo Moon landing missions and found to be orders of magnitude lower than this at 164 milli Grays (mGy) per year [6]. Gamma-ray photons from deep space have high energies greater than 100 MeV, and the most energetic cosmic photons presently detected reach about 100 TeV [7]. This means that while the dosage may be low, individual photons are very energetic, and we may expect a wide range of effects on GSL in space.

We now know that lower doses of gamma radiation can cause graphene multi-layers to self-heal, and this means it might be possible to repair damaged regions of GSL with controlled doses of gamma radiation.

And finally, the very high levels of gamma radiation can cause the graphene layers to cross-link and form hexagonal diamond Lonsdaleite. This points to a novel technique to spot-weld layers of graphene in GSL.

My conclusion is that highly intense gamma radiation can destroy GSL. The overall dose of gamma radiation may be low, however, some of the gamma-ray photons are extremely energetic and may cause localised damage with a range of characteristics. The research points to an encouraging aspect: using low-intensity gamma radiation carefully can also create joins and repair GSL. This will need testing in space to be sure.

#### **References:**

1. Xa9745669, M. and Tschurlovits (1996). IAEA-CN-67/153 i What is ‘ionizing radiation’? [online] Available at: [https://www.osti.gov/etdeweb/servlets/purl/593131#:~:text=EURATOM%20Guideline%20\(1996\)%3A%20Ionizing](https://www.osti.gov/etdeweb/servlets/purl/593131#:~:text=EURATOM%20Guideline%20(1996)%3A%20Ionizing) [Accessed 16 Jul. 2023].



2. Anon (2020). Radiation: Ionizing radiation. [online] www.who.int. Available at: <https://www.who.int/news-room/questions-and-answers/item/radiation-ionizing-radiation> [Accessed 22 Jul. 2023].
  3. Nixon. A., 2021. The graphene and graphite landscape: Indications of unexplored territory. Nixene Journal, 5(10), pp.9-20
  4. Li, B., Feng, Y., Ding, K., Qian, G., Zhang, X. and Zhang, J. (2013). The effect of gamma ray irradiation on the structure of graphite and multi-walled carbon nanotubes. Carbon, 60, pp.186–192. doi: <https://doi.org/10.1016/j.carbon.2013.04.012>
  5. Cataldo, F. (2000). A Raman study on radiation-damaged graphite by  $\gamma$ -rays. Carbon, 38(4), pp.634–636. doi: [https://doi.org/10.1016/s0008-6223\(00\)00007-5](https://doi.org/10.1016/s0008-6223(00)00007-5)
  6. Lloyd, C. and Reeves, K. (2008). NASA Human Research Program Engagement and Communications Radiation iBook. [online] NASA, p.6. Available at: [https://www.nasa.gov/sites/default/files/atoms/files/nasa\\_space\\_radiation\\_ebook\\_0.pdf](https://www.nasa.gov/sites/default/files/atoms/files/nasa_space_radiation_ebook_0.pdf). (Average dose rate from the Apollo 16 and 17 missions 0.45mGy per day)
-

# Tether Materials (July 2023)

by Adrian Nixon, Board Member, ISEC

## Engaging with the Space Industry and General Public in the UK

“Hello, Adrian? We have been following your work on graphene and the space elevator. Would you like to present at Farnborough this year?”

The event turned out to be the Space Com Expo 2023, UK. I would get to present in a fireside chat format with Dr. Aphrodite Tomou, head of technology for Goodfellow. I know Aphrodite well, and make a point of associating with very bright people, so I said yes.

*Then I realised what I had agreed to.*

Space Comm Expo is the biggest space industry exhibition and conference in the UK; it is full of rocket scientists and space professionals. This audience could potentially be one of the most sceptical faced so far.

We were presenting in the Small Sats theatre on the first day of the event. The theatre area was packed with a full audience; well over a hundred people came, and from the stage, I could see even more were standing at the back.



Adrian Nixon and Dr. Aphrodite Tomou at Space Comm Expo

As you will know by now, I was pleasantly surprised by our reception. There is a growing awareness that the current methods of accessing space cannot scale to achieve the ambitious goals of the big actors.



Access to space has to be sustainable and scaleable

Rockets are good for lifting people, fast

They have limited capacity <sup>a</sup>

In 2021 rockets put one million kg of black carbon pollution directly into the stratosphere <sup>b</sup>

[a] Swan, P., Swan, C., Phister, P., Dotson, D., Bernard-Cooper, J. and Molloy, B., 2022. *The Green Road to Space*. ISEC Position Paper # 2021-1.  
[online] Santa Ana: International Space Elevator Consortium. Available at: <<https://static1.squarespace.com/static/5e35ef40fb280744e1b16f7b/t/9082e7524757a75a66311dad/619191657175/GreenRoad.pdf>> [Accessed 23 June 2022].  
[b] O'Callaghan, J. (2022). *Emissions from rocket launches could affect Earth's weather systems*. [online] New Scientist. Available at: <https://www.newscientist.com/article/2324367-emissions-from-rocket-launches-could-affect-earths-weather-systems/> [Accessed 2 June 2023].

Image credit: Bing image creator

A dual method of access to space is going to be needed. Rockets are required to lift people and urgent items through the Earth's radiation belts rapidly. However, another method is required in order to lift large amounts of mass because rockets can only deliver fractions of the launchpad mass to the destination

+ In the entire history of spaceflight, since 1957, only about 20,000 tons have been placed in low earth orbit (LEO) [1]

+ Rockets can only deliver 4% of the launch pad mass to LEO and 2% of the launchpad mass to geostationary orbit (GEO) [2]

+ A single space elevator can lift about 30,000 tons to GEO every year [1]

The other issue that people in the space industry are starting to consider is the pollution rockets create.

+ In 2021, rockets put one million kg of black carbon pollution directly into the stratosphere [3]

No one knows how this will affect our planet, particularly as more and more rockets are launched through the earth's atmosphere.

I expected to be treated with polite disdain by the space industry professionals. I was pleasantly surprised to find that many people in the audience had heard of the latest developments in tether materials and were prepared to consider the possibility that the space elevator could be built.

Two-dimensional (2D) materials, such as graphene, are already being made in industrial quantities. The companies engaged in this endeavour have yet to create tether quality material, but the groundwork is being laid.

Companies such as Galactic Harbour Associates (GHA) have even started to create realistic images of what a tether made from 2D materials would look like [4].

---

# Tether Materials (June 2023)

by Adrian Nixon, Board Member, ISEC

## A Graphene Super Laminate Tether may be More Resilient to Heating than We Thought

In our last newsletter, we examined how the strength of a tether is affected by heat. This prompted a dialogue with some of the ISEC members, and as usual, you made me think more deeply about the way tether materials respond to heating. For this article, I shall focus on a tether made from graphene. More specifically, multi-layered graphene super laminate (GSL).

You will recall we found that the tensile strength decreases proportionately depending on how hot the material becomes. In the temperature range encountered in space around the Earth, this amounted to a 10% reduction in the strength of the candidate materials.

On to our dialogue...

### **Can we shadow or shade the tether to mitigate the heat effects?**

Creating a sunshade for the tether probably means building some kind of tube inside of which the tether and the climber will operate. Making the tube will be a bigger challenge than making the tether.

Therefore, the answer would be a straightforward, No.

### **Does the tether heat and cool quickly?**

To answer this, we need to know the speed with which the heat carriers operate. These heat carriers are waves or ripples in the graphene sheet (crystal lattice) and are called acoustic phonons (they are called acoustic because they move at the speed of sound in a material)

A Chinese Academy of Sciences team has done this work [2]. They found that "The corresponding sound velocities 12.9 to 19.9 km/s of graphene have been accessed."

This means that heat transfer in graphene is fast, at least 13 kilometres per second—so any heat generated won't hang around locally for very long and will be distributed to the edges and down the whole tether at high speed.

A tether made from GSL will heat and cool very quickly.

### **How long does it take to go from a weak tether to a strong tether?**

Take away the heat, and the strength returns. We know from the work in China [2] that this will be instant.

### How large is the heat transfer?

Graphene has one of the highest in-plane thermal conductivities of any material (5000 W/mK) [3]. The bigger the number, the better the heat transfer. To give you an idea of how good this is, the following table has some other materials for comparison.

Material	Thermal conductivity (W/mK)	Source
Graphene (in-plane)	5000	[3]
Copper	385	[4]
Aluminium	205	[4]
Steel	50	[4]
Graphene (cross-plane)	6.8	[5]

Note that graphene has the highest in-plane thermal conductivity, the x/y direction. Graphene also has the lowest cross-plane thermal conductivity, nearly one thousand times less in the z direction. It is an anisotropic material with respect to its response to heat.

Graphene also has the highest melting point of any known material. The initial stages of melting of graphene are between 4000 K and 6000 K [6].

### How localised is the heat transfer?

Graphene (and GSL) will want to move the heat away from the local area as fast as possible so the heat will be distributed across the material at very fast speeds.

The heat transfer is not localised at all.

### What happens to the heat?

Heat is dissipated in two ways:

1. Conduction: Transfer of heat where the tether is in physical contact with gases, liquids, or solids. As we have seen from the thermal conductivity of graphene, the heat will spread rapidly through the tether material as vibrations in the crystal lattice (acoustic phonons). The heat will then be conducted away from the tether depending on what medium it is in contact with. When the tether is in the vacuum of space, heat energy transfer by conduction is not possible because there is nothing for the tether to be in physical contact with. This is when emissivity predominates.

2. Emissivity: This is the other way for heat energy to be dissipated. The energy is emitted as infrared radiation. The efficiency of the heat transfer is measured by its emissivity. A number close to one is more efficient than a smaller number. Laboratory tests heating multilayer graphene by electricity on a glass substrate have found emissivity values in the range from 0.91 to 0.72 when the number of

graphene layers was changed from 1 to 12 [7]. This indicates a high level of heat transfer by emissivity for a tether made from graphene, as the heat will be contained in the outer layers of the material.

## Thermal conductivity and emissivity

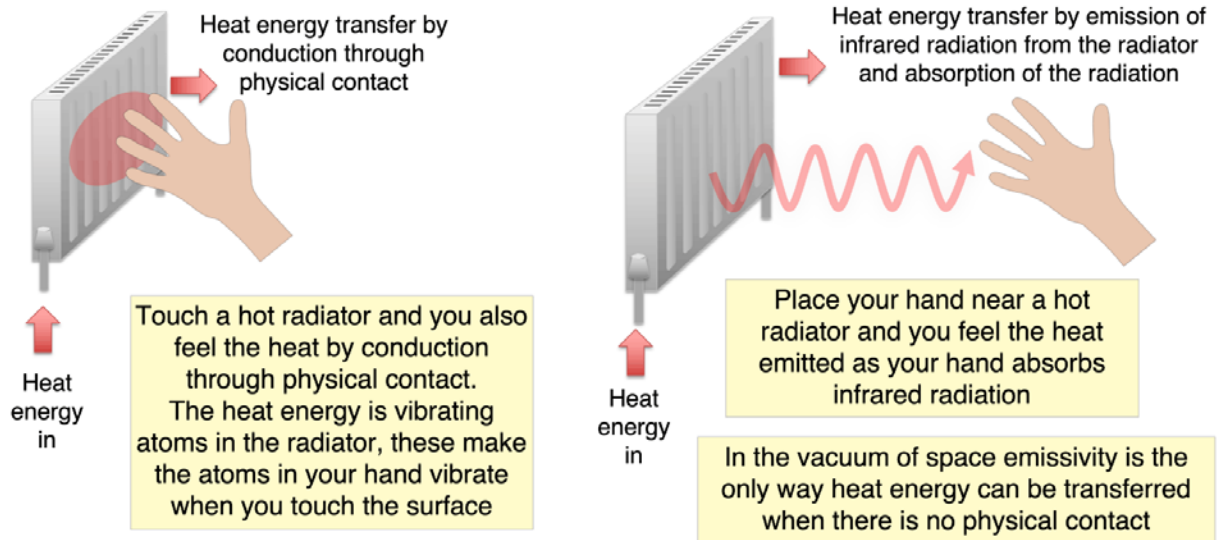

**Conclusion: The tether will be more heat resistant than we thought.**

The dialogue with my ISEC colleagues made us realise that the exceptional thermal conductivity properties would mitigate the adverse effects of heat on the tensile strength of a tether made from two-dimensional materials. Heat is spread far and wide through the material at speeds of over 13 kilometres per second. Also, the anisotropic thermal conductivity makes heat percolate between graphene layers in GSL nearly one thousand times less than within each layer. This means a tether made from GSL will just heat up in the outer few layers while the inner structure is insulated by the layers on the outside.

**A final thought:** The academic results that show the loss of strength with heating contain an important assumption. The whole structure is heated at the same time. A graphene tether will only heat up in localised parts, and the heat will be rapidly spread and dissipated throughout the whole of the structure. **This means a tether made from GSL will be far more resilient to heating than we originally thought.**

My thanks go to Michael (Fitzer) Fitzgerald and Larry Bartoszek for improving the critical thinking of this topic.

### References:

1. Zhang, Y.Y. and Gu, Y.T. (2013). Mechanical properties of graphene: Effects of layer number, temperature and isotope. Computational Materials Science, 71, pp.197–200. doi: <https://doi.org/10.1016/j.commatsci.2013.01.032>.

2. Cong, X., Li, Q.-Q., Zhang, X., Lin, M.-L., Wu, J.-B., Liu, X.-L., Venezuela, P. and Tan, P.-H. (2019). Probing the acoustic phonon dispersion and sound velocity of graphene by Raman spectroscopy. *Carbon*, 149, pp.19–24. doi: <https://doi.org/10.1016/j.carbon.2019.04.006>.
  3. Anon (2010). Scientific Background on the Nobel Prize in Physics 2010 Graphene, compiled by the Class for Physics of the Royal Swedish Academy of Sciences. [online] Nobelprize.org, Sweden: Nobel Foundation, p.8. Available at: <https://www.nobelprize.org/uploads/2018/06/advanced-physicsprize2010.pdf> [Accessed 12 Jan. 2023].
  4. Anon (n.d.). Nondestructive Evaluation Physics : Materials. [online] www.nde-ed.org. Available at: [https://www.nde-ed.org/Physics/Materials/Physical\\_Chemical/ThermalConductivity.xhtml](https://www.nde-ed.org/Physics/Materials/Physical_Chemical/ThermalConductivity.xhtml) [Accessed 25 May 2023].
  5. Ouyang, W., Qin, H., Urbakh, M. and Hod, O., 2020. Controllable Thermal Conductivity in Twisted Homogeneous Interfaces of Graphene and Hexagonal Boron Nitride. *Nano Letters*, 20(10), pp.7513-7518.
  6. Ganz, E., Ganz, A.B., Yang, L.-M. and Dornfeld, M. (2017). The initial stages of melting of graphene between 4000 K and 6000 K. *Physical Chemistry Chemical Physics*, 19(5), pp.3756–3762. doi: <https://doi.org/10.1039/c6cp06940a>.
  7. Kyung Woo Park, Lim Mikyung, Jung, H.-J. and Jae Nyoung Kim (2021). Thermal Radiative Properties of Multilayer Graphene/Glass Structure. *The journal of the Korean Institute of Electrical and Electronic Material Engineers*, 34(1), pp.27–32. doi: <https://doi.org/10.4313/jkem.2021.34.1.27>.
-



# Tether Materials (May 2023)

by Adrian Nixon, Board Member, ISEC

## How Tether Materials' Tensile Strength Responds to Temperature

As materials are heated, their strength decreases. This is because the bonds between atoms vibrate by stretching and bending as energy is transferred to the material by heating. The more heat, the greater the movement, thus weakening the bonds, and the tensile strength decreases accordingly.

Just how much strength is lost by tether materials as they become hotter has been the subject of several studies. This work has been conducted by computer simulation rather than actual experimentation, but this will give us a good guide to the behaviour of these materials in practise. Studies using molecular dynamics simulations have been conducted for graphene, single-walled carbon nanotubes, and hexagonal boron nitride.

A sample of graphene, 20nm long and 6nm wide, was simulated and it was found that the tensile strength reduced from 125.87 to 42.93 GPa when the temperature increased from 300K to 2000K, indicating a reduction by 65.89% [1].

Another study [2] modelled single-walled carbon nanotubes and found that the tensile strength decreased from 83.23 GPa at 300K to 43.78 GPa at 1800K. The calculated tensile strength of the carbon nanotubes seems to be rather low. We would have expected CNTs to be at least as strong as graphene and possibly stronger. The study does not explain this difference as we don't have access to the assumptions programmed into the computer model used to create the simulation. While we await further results, this data is the best published evidence at present.

The tensile strength performance of hexagonal boron nitride (hBN) has also been modelled [3]. The strength results were comparable with those of graphene and declined similarly as the temperature increased. The following chart shows the results as trendlines.

# Effect of temperature on the tensile strength of candidate tether materials by computer simulation

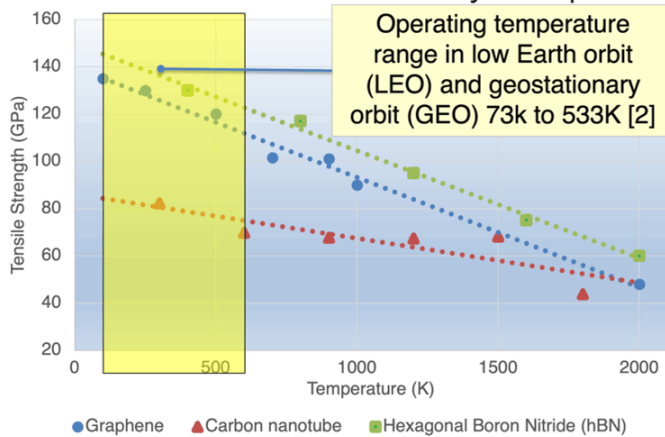

Molecular dynamics (MD) simulations were used to simulate the effect of temperature on the tensile strength of:

- Graphene [1]
- Single walled carbon nanotubes [3]
- Hexagonal boron nitride [4]

## Sources:

1. Zhang, Y.Y. and Gu, Y.T. (2013). Mechanical properties of graphene: Effects of layer number, temperature and isotope. *Computational Materials Science*, 71, pp.197–200. doi:<https://doi.org/10.1016/j.commatsci.2013.01.032>.
2. Plante, J. and Lee, B. (2014). *Environmental Conditions for Space Flight Hardware – A Survey*. [online] NASA.gov. Available at: [https://npp.nasa.gov/docuploads/C5E0869C-0469-4D11-9FAA8012C8F52351/environmental Testing Survey.doc](https://npp.nasa.gov/docuploads/C5E0869C-0469-4D11-9FAA8012C8F52351/environmental%20Testing%20Survey.doc).
3. Dereli, G. and Süngü, B. (2007). Temperature dependence of the tensile properties of single-walled carbon nanotubes: O(N)tight-binding molecular-dynamics simulations. *Physical Review B*, 75(18).doi:<https://doi.org/10.1103/physrevb.75.184104>.
4. Han, T., Luo, Y. and Wang, C. (2013). Effects of temperature and strain rate on the mechanical properties of hexagonal boron nitride nanosheets. *Journal of Physics D: Applied Physics*, 47(2), p.025303. doi:<https://doi.org/10.1088/0022-3727/47/2/025303>.

## Tensile strength and temperature for tether candidate materials

What temperature extremes might we encounter in space around the Earth? To find out, a study commissioned by NASA investigated the temperatures in Earth's orbit [4]. The work found that the temperatures varied between 73k to 533K at low earth orbit and geostationary orbit. Over this range, the strength of the tether materials decreased by approximately 10% from their initial values. This means that all the candidate materials for the space elevator tether will still be strong enough to perform under tension over the range of temperatures encountered by structures as they orbit the Earth.

## References:

1. Zhang, Y.Y. and Gu, Y.T. (2013). Mechanical properties of graphene: Effects of layer number, temperature and isotope. *Computational Materials Science*, 71, pp.197–200. <https://www.sciencedirect.com/science/article/abs/pii/S0927025613000487>.
2. Plante, J. and Lee, B. (2014). *Environmental Conditions for Space Flight Hardware – A Survey*. [online] NASA.gov. Available at: <https://ntrs.nasa.gov/api/citations/20060013394/downloads/20060013394.pdf>
3. Dereli, G. and Süngü, B. (2007). Temperature dependence of the tensile properties of single-walled carbon nanotubes: O(N)tight-binding molecular-dynamics simulations. *Physical Review B*, 75(18). <https://journals.aps.org/prb/abstract/10.1103/PhysRevB.75.184104>.
4. Han, T., Luo, Y. and Wang, C. (2013). Effects of temperature and strain rate on the mechanical properties of hexagonal boron nitride nanosheets. *Journal of Physics D: Applied Physics*, 47(2), p.025303. <https://iopscience.iop.org/article/10.1088/0022-3727/47/2/025303>.

# Tether Materials (April 2023)

by Adrian Nixon, Board Member, ISEC

## How Tether Materials Resist Tearing

Tether materials have incredibly strong tensile strengths. It takes a lot of energy to pull them apart. There are very few materials with the strength needed which is why, at the time of writing, there are only three main candidates: Carbon nanotubes, graphene, and hexagonal boron nitride (hBN). The current assumption is that we will need single crystals of these materials. This means a perfectly repeating pattern of bonds with no grain boundaries or gaps in the material (vacancies).

While these candidate materials are incredibly strong in tension, how these materials will resist fracturing (tearing in 2D materials) is a failure mode that needs to be considered. Fracture toughness is a measure of a material's ability to resist crack propagation. It is typically measured by the amount of energy required to fracture a material, normalized by its cross-sectional area.

Fracture toughness can be determined by test method ASTM E399-22. It "characterizes the resistance of a material to fracture in a neutral environment in the presence of a sharp crack under essentially linear-elastic stress and severe tensile constraint, such that the state of stress near the crack front approaches triaxial plane strain, and the crack-tip plastic zone is small compared to the crack size, specimen thickness, and ligament ahead of the crack." [1].

The fracture toughness for single-walled carbon nanotubes has been measured by computer simulation of introduced vacancies in the tube wall at  $2.9 \pm 0.3 \text{ MPa m}^{0.5}$  [2]. The fracture toughness of single crystal graphene has been experimentally measured by introducing a crack at the edge of the sheet at  $4.0 \pm 0.6 \text{ MPa m}^{0.5}$  [3]. The fracture toughness of single crystal hexagonal boron nitride has been experimentally measured by introducing a crack at the edge of the sheet at  $8.7 \text{ MPa m}^{0.5}$  [4].

# Fracture toughness in carbon nanotubes, graphene and hexagonal boron nitride (hBN)

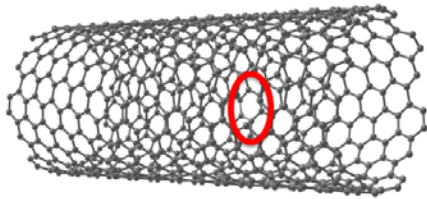

Fracture toughness for single walled carbon nanotubes measured at  $2.9 \pm 0.3 \text{ MPa m}^{0.5}$

Each material has defects deliberately introduced  
Once fracture cracks start, they can travel right through the 2D material, and the force required to propagate them can be measured

Source:  
Yang, L., Greenfeld, I. and Wagner, H.D. (2016). Toughness of carbon nanotubes conforms to classic fracture mechanics. *Science Advances*, 2(2).

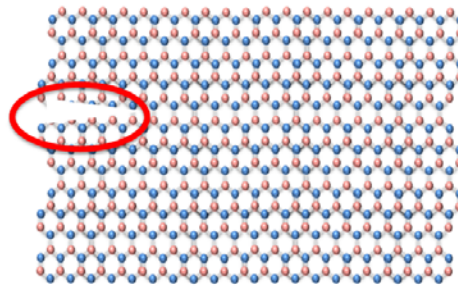
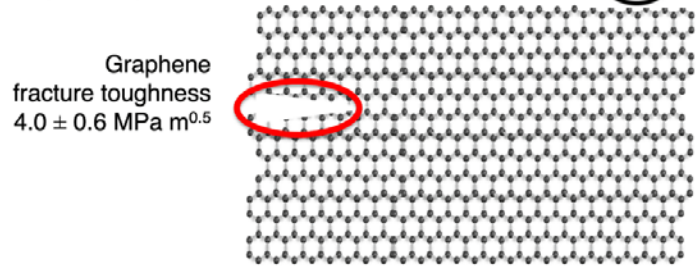

hBN fracture toughness  $8.7 \text{ MPa m}^{0.5}$

● Boron (B) ● Nitrogen (N) ● Carbon (C)

The fracture toughness values of the candidate tether materials are typical of moderately brittle materials. The values reside in the high-end range of ceramics ( $0.2$  to  $5 \text{ MPa m}^{0.5}$ ) and polymers ( $0.4$  to  $4 \text{ MPa m}^{0.5}$ ) and are lower than the values of metals and alloys ( $5$  to  $200 \text{ MPa m}^{0.5}$ ). They are higher than the values of glass ( $0.8 \text{ MPa m}^{0.5}$ ) and epoxy ( $0.4 \text{ MPa m}^{0.5}$ ) and comparable with those of nylon ( $3 \text{ MPa m}^{0.5}$ ) and alumina ( $4 \text{ MPa m}^{0.5}$ ) [2].

Further work has demonstrated that in polycrystalline graphene, the grain boundaries deflect the propagation of cracks, and this can increase the fracture toughness. The fracture of a single C–C bond at the crack tip of single-crystal graphene under tearing load was analysed from the atomic view. The work found that the fracture toughness of the single C–C bond occupied about half of the fracture toughness for the complete failure of the total single-crystal graphene, and the other half of the energy distributes in the rest of the graphene. [5].

This means that the presence of grain boundaries in polycrystalline graphene could potentially double the fracture toughness of the material. This should also be true for the other tether candidate materials, provided no vacancy defects exist.

Polycrystalline graphene may be stronger than expected provided there are no vacancies in the graphene sheet. Molecular dynamics modelling results suggest that polycrystalline graphene sheets with average grain sizes greater than  $2 \text{ nm}$  present an ultrahigh tensile strength of around  $85 \text{ GPa}$ , which is two orders of magnitude higher than that of high-strength steels and titanium alloys [6]. Furthermore, the study concluded that ultra-fine-grained graphene structures have ultrahigh tensile strength and elastic modulus values that are very close to those for defect-free single crystal graphene sheets ( $130 \text{ GPa}$ ).

So, our assumption that we will need perfect single crystal materials needs challenging. It could be that grain boundary defects will make our candidate materials tougher in use while maintaining sufficient strength in tension for the space elevator tether.

#### References:

1. www.astm.org. (2022). Standard Test Method for Linear-Elastic Plane-Strain Fracture Toughness of Metallic Materials. [online] Available at: <https://www.astm.org/e0399-22.html>.
  2. Yang, L., Greenfeld, I. and Wagner, H.D. (2016). Toughness of carbon nanotubes conforms to classic fracture mechanics. *Science Advances*, 2(2).
  3. Zhang, P., Ma, L., Fan, F., Zeng, Z., Peng, C., Loya, P.E., Liu, Z., Gong, Y., Zhang, J., Zhang, X., Ajayan, P.M., Zhu, T. and Lou, J. (2014). Fracture toughness of graphene. *Nature Communications*, [online] 5(1), pp.1–7. Available at: <https://www.nature.com/articles/ncomms4782>
  4. Yang, Y., Song, Z., Lu, G., Zhang, Q., Zhang, B., Ni, B., Wang, C., Li, X., Gu, L., Xie, X., Gao, H. and Lou, J. (2021). Intrinsic toughening and stable crack propagation in hexagonal boron nitride. *Nature*, 594(7861), pp.57–61.
  5. Wang, Y. and Liu, Z. (2016). The fracture toughness of graphene during the tearing process. *Modelling and Simulation in Materials Science and Engineering*, 24(8), p.085002.
  6. Mortazavi, B. and Cuniberti, G. (2014). Atomistic modelling of mechanical properties of polycrystalline graphene. *Nanotechnology*, 25(21), p.215704.
-

# Tether Materials (March 2023)

by Adrian Nixon, Board Member, ISEC

## Sliding of Layers in Graphene Super Laminate

In the previous newsletter we explored the friction of a tether made from many layers of single crystal graphene that we term Graphene Super Laminate (GSL)[1]. GSL has yet to be made at scale. Regular readers, however, will know that graphene is routinely manufactured and is the subject of laboratory testing. Our study of the literature has shown that graphene is a substance that occupies the border between high friction (frictant) and low friction (lubricant) materials.

Friction is important because the current best design for the climber relies on opposing wheels that grip the tether. You will know from the previous newsletter that our current view is that the peer reviewed literature point towards values for friction that are towards the higher end of the range [2]. This means that the tether will be climbable using current engineering designs.

All good so far, then my colleague Larry Bartoszek noticed something in one of the experiments conducted by researchers at the Tandon School of Engineering, New York University [3]. The researchers were testing the response of multi-layered graphene and the found that the higher the shear modulus (the ability of the tether material to transfer the load of the climber from the outermost layers to inner layers), the lower the coefficient of friction. This means that as the tether is gripped, the layers slide over one another. This is hardly an ideal response from a material. So, what is causing this and how might we solve this problem?

In Graphene Super Laminate, the individual layers are incredibly strong in the x/y direction with an ultimate tensile strength of 130 GPa. The graphene layers are stacked in the z direction and held together with the van der Waals force. This is an electrostatic attraction between the positively charged protons in the nuclei of the carbon atoms in one layer of graphene and the negatively charged electrons in an adjacent graphene layer.

# Van der Waals bonding in graphene super laminate

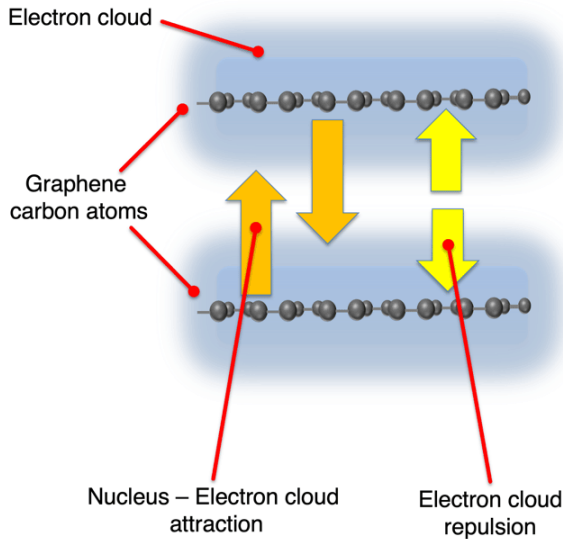

In layered graphene the layers are held together by the attraction between the positively charge nucleus of the carbon atoms in one layer with the negatively charged electron cloud in an adjacent layer.

This electrostatic attraction is the van der Waals force.

The van der Waals force is quite weak, but becomes significant in 2d materials such as layered graphene because they have a huge surface area

The attractive force is countered by a repulsive force between the electron clouds surrounding each graphene layer

The balance of attractive and repulsive forces gives the length of the van der Waals bond, in graphene this is 0.335 nanometres

The van der Waals force holds the graphene layers together without the need for glue. The individual attractive forces are quite weak when compared with the covalent bonds between carbon atoms within the graphene layers. However, graphene is a two-dimensional (2D) material and as such is all surface area, so the small forces multiply and keep the graphene super laminate a coherent structure.

The van der Waals force is less resistant to shear forces. Because it is an electrostatic rather than covalent bond there is less strength when subjected to sideways movement. This means layers in graphene super laminate can slide over one another.

## Sliding of graphene layers in graphene super laminate

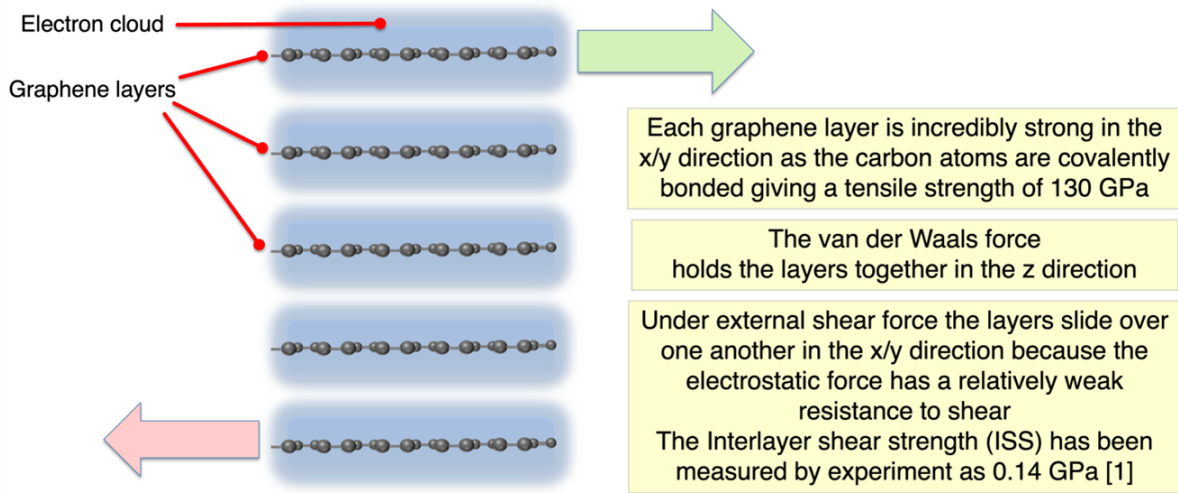

Source:  
Liu, Z., Zhang, S.-M., Yang, J.-R., Liu, J.Z., Yang, Y.-L. and Zheng, Q.-S. (2012). Interlayer shear strength of single crystalline graphite. *Acta Mechanica Sinica*, 28(4), pp.978–982. doi:<https://doi.org/10.1007/s10409-012-0137-0>.

The resistance to sliding is called the interlayer shear strength and has been measured as 0.14 GPa [4].

So, we now know that a tether made from graphene super laminate is very strong within the layers, but the layers will slide over one another when gripped by a climber because the electrostatic van der Waals forces are not as strong as the covalent bonds within the graphene.

This gives us a clue how we can solve the interlayer slipping problem. The key is to form covalent bonds between the graphene layers. We know that graphene layers can be crosslinked forming localised areas of diamond, we called this “spot welding”.

We detailed how the spot welding between the layers can be made in a previous ISEC newsletter entry [5].





Stick-and-ball model of “spot-welded” multilayer graphene. The  $sp^3$  hybrid bonds are shown in the centre, between two layers of graphene.

This spot-welding will solve the layer slipping problem and could also help solve other problems associated with deploying a tether. That, however, is another story that we will explore in a future newsletter.

#### References:

1. Nixon, A. (2022). 2022 August International Space Elevator Consortium Newsletter. [online] International Space Elevator Consortium. Available at: <https://www.isec.org/space-elevator-newsletter-2022-august/#tether> [Accessed 23 Jan. 2023].
2. Nixon, A. (2023). 2023 February International Space Elevator Consortium Newsletter. [online] International Space Elevator Consortium. Available at: <https://www.isec.org/space-elevator-newsletter-2023-february/#tether> [Accessed 21 Feb. 2023].
3. Rejhon, M., Lavini, F., Khosravi, A., Shestopalov, M., Kunc, J., Tosatti, E. and Riedo, E. (2022). Relation between interfacial shear and friction force in 2D materials. *Nature Nanotechnology*. doi: <https://doi.org/10.1038/s41565-022-01237-7>.
4. Liu, Z., Zhang, S.-M., Yang, J.-R., Liu, J.Z., Yang, Y.-L. and Zheng, Q.-S. (2012). Interlayer shear strength of single crystalline graphite. *Acta Mechanica Sinica*, 28(4), pp.978–982. doi: <https://doi.org/10.1007/s10409-012-0137-0>

5. Nixon, A. (2022). 2022 September International Space Elevator Consortium Newsletter. [online] International Space Elevator Consortium. Available at: <https://www.isec.org/space-elevator-newsletter-2022-september/#tether> [Accessed 22 Feb. 2023].

---

# Tether Materials (February 2023)

by Adrian Nixon, Board Member, ISEC

## Measuring the Friction of Graphene Super Laminate

A space elevator tether material needs to be incredibly strong and lightweight. It also needs to be gripped by a climber that can haul itself up - and control its descent. The coefficient of friction of material combinations is one key property we need to be aware of. The higher the number, the more grip we can obtain. For the purposes of this article, we will refer to the steady state coefficient of friction ( $\mu$ ) [1].

Friction has been a particularly important consideration for the climber-tether interface study group. One of the early tasks we set ourselves was to establish whether a climber could climb the tether given the engineering and materials assumptions we had chosen. One of the current assumptions is that the tether will be made from continuous layers of graphene that we term graphene super laminate (GSL) [2].

Simple question: What is the coefficient of friction of GSL?

The answer is not quite as straightforward as you might expect. Firstly, friction is always an emergent property of two (or more) materials. So, we need to define what the other materials are. Secondly, GSL has not been made in quantities we can use for testing at present. However, we can use data from monolayer and multilayer graphene as a good guide. Our research of the peer reviewed literature has helped us build a database of graphene material properties. Early searches of the literature produced coefficient of friction values for graphene of 0.1 to 0.15 with sapphire-graphene and graphene-graphene [3, 4].

All good so far, until we repeated the literature search and found a completely different result. Separate research teams have published work showing graphene-diamond has a coefficient of friction in the range 0.01 to 0.05 [5, 6].

Two sets of friction measurements of graphene and an order of magnitude difference between them. What is going on?

Part of the answer is the material combinations, with diamond-graphene giving the lower friction results. There is another factor at play here. The results around 0.01 were obtained with atomic force microscopes and the results around 0.1 were produced by ball and plate methods.

Does all this matter?

Yes, this is quite important because with a materials interaction coefficient of friction around 0.1 we will be able to engineer climbers to climb the tether. However, if the coefficient of friction is ten times lower around 0.01, the task becomes much, much harder.

So, which value is correct?

They both are.

This apparent paradox can be resolved if you think about the equipment used to measure the friction. The tests with diamond on graphene were performed with atomic force microscopes. As the name suggests these operate at the scale of atoms, fractions of a nanometre. The ball on plate method operates from the nanoscale through the microscale. This is good news for our engineering designs because it points to friction being closer to the higher number as the scale increases.

The current best engineering design for the climber is a set of opposing titanium wheels clamped on either side of a flat ribbon of GSL tether.

When we get samples of GSL to test at the macroscale (the scale of our everyday experience), we can test the hypothesis that the coefficient of friction for materials such as titanium wheels and a graphene tether will be at least 0.1 and possibly higher.

A final thought...

During the writing of this newsletter article, we realised that while low friction materials were described as lubricants, there was no term for high friction materials. Several searches for the antonym for 'lubricant' revealed nothing useful. Dr. Dennis Wright proposed the term 'frictant' to describe higher friction material combinations.

For our purposes we might consider a coefficient of friction around 0.1 to be the watershed below which materials could be described as lubricants and above 0.1, materials could be considered as frictants.

I would also like to thank Larry Bartoszek for his thoughtful insights into the nature of friction.

#### References:

1. Scharf, T.W. and Prasad, S.V. (2012). Solid lubricants: a review. *Journal of Materials Science*, 48(2), pp.511–531. doi: <https://doi.org/10.1007/s10853-012-7038-2>.
2. Nixon, A. (2022). 2022 August International Space Elevator Consortium Newsletter. [online] International Space Elevator Consortium. Available at: <https://www.isec.org/space-elevator-newsletter-2022-august/#tether> [Accessed 23 Jan. 2023].
3. Dwivedi, N., Ott, A.K., Sasikumar, K., Dou, C., Yeo, R.J., Narayanan, B., Sassi, U., Fazio, D.D., Soavi, G., Dutta, T., Balci, O., Shinde, S., Zhang, J., Katiyar, A.K., Keatley, P.S., Srivastava, A.K., Sankaranarayanan, S.K.R.S., Ferrari, A.C. and Bhatia, C.S. (2021). Graphene overcoats for ultra-high storage density magnetic media. *Nature Communications*, 12(1). doi: <https://doi.org/10.1038/s41467-021-22687-y>.

4. Zhang, Z., Du, Y., Huang, S., Meng, F., Chen, L., Xie, W., Chang, K., Zhang, C., Lu, Y., Lin, C., Li, S., Parkin, I.P. and Guo, D. (2020). Macroscale Superlubricity Enabled by Graphene-Coated Surfaces. *Advanced Science*, 7(4), p.1903239. doi: <https://doi.org/10.1002/adv.201903239>.
  5. Yang, L., Zhang, Q. and Diao, D. (2016). Cross-Linking-Induced Frictional Behavior of Multilayer Graphene: Origin of Friction. *Tribology Letters*, 62(2). doi: <https://doi.org/10.1007/s11249-016-0681-z>.
-

# Tether Materials (December 2022)

by Adrian Nixon, Board Member, ISEC

## ISO Standards for Large-area Sheet Graphene

Regular readers of the tether materials section of the newsletter will know there are three candidate materials. Of these, graphene is the most likely material that can be made in the quantities needed for the tether. Dear reader, you will also know that graphene can be manufactured in two forms, as a powder and large-area, one atom thin graphene made by the chemical vapour deposition (CVD) method. Look closely at the copper foil in fig1. and you can actually see the one atom thin layer of graphene as a lighter, slightly more silvery coating on the majority of the right-hand side of the metal surface.

### Graphene powder and large-area sheet CVD graphene



Two types of graphene manufacturing



Graphene can be manufactured as powders and dispersions.

Graphene can also be made as a one atom thin layer.

Single layer large-area chemical vapour deposition (CDV) graphene on metal foil

Observe the dark line at the left hand side; this is the bare copper metal – the rest of the surface is covered by one atom thin layer of graphene

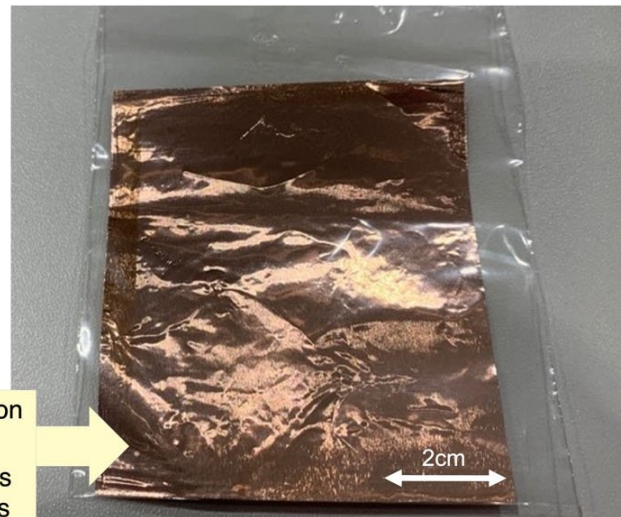

One atom thin graphene on copper foil  
Image credit: Adrian Nixon

Figure 1: Graphene powder and one atom thin large-area CVD graphene on metal foil.

Powdered graphene is enjoying commercial success as a performance additive conferring enhanced mechanical and electrical properties on many other materials. However, it is CVD graphene that is the tether candidate material.

The International Standards Organisation (ISO) has an important role to play in specifying the sequence of methods for characterising the structural properties of graphene as well as the language used to describe the material. This is documented in ISO/TS 21356-1:2021 [1]. This international standard is the culmination of several years' work by an international team representing all the interested countries of the world.

Impressive as this ISO standard is, it is worth noting that this just applies to graphene powders and dispersions made from graphene powders.

However, work has just started on a new graphene standard. The technical committee responsible for creating these standards is called ISO/TC 229. The chair of the committee is Dr Denis Koltsov.

Denis contacted me a few days ago to let us know that the International Standards Organisation is now beginning to develop the standards for characterising CVD graphene.

## International Standards Organisation (ISO) begins to focus on large area sheet graphene



A screenshot of the ISO website. The top navigation bar includes 'Standards', 'About us', 'News', 'Taking part', and 'Store'. A search bar is on the right. Below the navigation, there is a breadcrumb trail: '← TC ← ISO/TC 229'. The main heading is 'ISO/AWI TS 21356-2' followed by 'Nanotechnologies — Structural characterization of graphene — Part 2: Chemical vapour deposition (CVD) grown graphene'. Below this is an 'Abstract' section with a small text block. Underneath is a 'General information' section with a small icon. The status is 'Under development', the edition is '1', and the technical committee is 'ISO/TC 229 Nanotechnologies'. The ICS field is empty.

Source:  
Anon (2022). *ISO/AWI TS 21356-2*. [online] ISO. Available at:  
<https://www.iso.org/cms/%20render/live/en/sites/isoorg/contents/data/standard/08/34/83449.html?browse=tc> [Accessed 21 Nov. 2022].

Figure 2: The International Standards Organisation announcement about the structural characterisation of large-area (Chemical Vapour Deposition or CVD) graphene.

This is very good news. It means that the international community is taking CVD graphene seriously, and this will lead to agreement about which methods should be used to measure and characterise the one atom thin layers of material you can see in Fig1.

The ISO standards will focus the attention of the international technical community, and this will help drive the development of measurement techniques for CVD graphene.

The manufacture of graphene as a tether material will need to be made as a high-quality product. The international community is beginning to get organised, and these standards will lay the foundations for future quality control and quality assurance methods of the future. Thank you, Denis, we wish you and your global technical committee well developing these standards.

References:



1. Anon (2021). ISO/TS 21356-1:2021. [online] ISO. Available at:  
<https://www.iso.org/standard/70757.html>. [Accessed 21 Nov. 2022].

2. Anon (2022). ISO/AWI TS 21356-2. [online] ISO. Available at:  
<https://www.iso.org/cms/%20render/live/en/sites/isoorg/contents/data/standard/08/34/83449.html>  
[Accessed 21 Nov. 2022].

---

# Tether Materials (November 2022)

by Adrian Nixon, Board Member, ISEC

## Snowflake Graphene

Regular readers will know that graphene is currently manufactured by the chemical vapour deposition (CVD) process. This involves heating methane and hydrogen to around 1000° C near a smooth metal surface, usually copper foil.

Industrial manufacturing technology still has some way to go before tether quality graphene can be routinely made. One of the issues is the quality of the graphene.

A tether needs to be made from tens of thousands of individual layers of graphene rather like the pages of a book. Each of these layers needs to be as free from defects as possible.

The language we use is to describe defect free graphene as 'single crystal' and graphene containing defects is described as 'polycrystalline'.

General Graphene is an industrial manufacturer of CVD graphene, based in the USA, and one of their scientists released an image of a test sample for a photographic competition [1]. It will help you understand how defects arise when making graphene.

### 'Snowflake' CVD graphene made by General Graphene

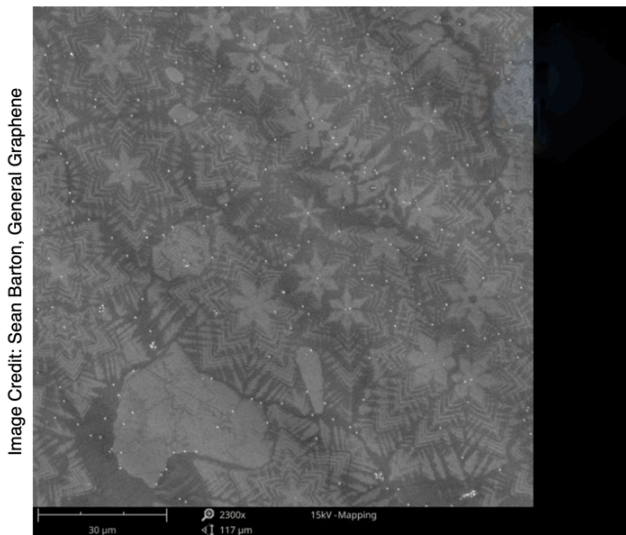

Image Credit: Sean Barton, General Graphene

This electron microscope image is magnified by 2500 times and shows chemical vapour deposition (CVD) graphene made on copper foil by General Graphene in the USA

The crystal domain growth was deliberately halted during the growth process by introducing some ambient atmosphere

If the domains were allowed to complete their growth, the misalignments would create polycrystalline graphene

Source:  
Barton, S. (2022). *Snowflake graphene*. [online] LinkedIn. Available at: <https://www.linkedin.com/feed/update/urn:li:activity:6991201503273242625/> [Accessed 27 Oct. 2022].

The image was made using an electron microscope that magnified a graphene sample on copper foil by 2,500 times. It shows a rather elegant snowflake pattern. The 'snowflakes' are one atom thin crystals of graphene on the surface of the copper foil.

The snowflake pattern is caused by graphene crystal domains growing from multiple places on the copper foil at the same time. Think of frost growing on a window and you'll get the idea. In the picture above the growth process was deliberately halted by allowing in oxygen from the ambient air. This revealed the growing process in all its intricate glory.

The crystal domains start to grow independently of one another. This means their crystalline patterns are randomly oriented relative to the other domains. As the domains grow, they eventually collide. Where they are aligned, they connect to form a single crystal. Where they are misaligned, they create crystal defect boundaries, called Stone-Wales defects [2].

This illustrates just one of the challenges of making single crystal graphene of tether quality. You will appreciate there are many others. The key to solving problems is to identify them in the first place. This problem has its solutions and single crystal graphene has already been made in the laboratory.

The reason for telling you all this is to convey the understanding that making graphene is hard. Manufacturing single crystal graphene for the space elevator tether is even harder. However, it is not impossible and that is what makes our work exciting.

## References

[1] Barton, S. (2022). Snowflake graphene. [online] LinkedIn. Available at:

<https://www.linkedin.com/feed/update/urn:li:activity:6991201503273242625/>

[Accessed 27 Oct. 2022].

[2] Nixon, A. (2021) "The graphene and graphite landscape: Indications of unexplored territory." Nixene Journal 5 (10) 8-19.

---

# Tether Materials (October 2022)

by Adrian Nixon, Board Member, ISEC

## Borophene

Several of our regular readers asked me about a new two-dimensional (2D) material called Borophene. This material was purely theoretical until researchers at Rice and Northwestern Universities in the USA made samples of the material last year. I was asked “could this be a candidate material for the space elevator tether?”

Borophene is the name given to a new material that is analogous to graphene. Graphene is made from carbon, borophene is made from boron atoms.

Rice and Northwestern researchers create new 2D material:  
bi-layer borophene

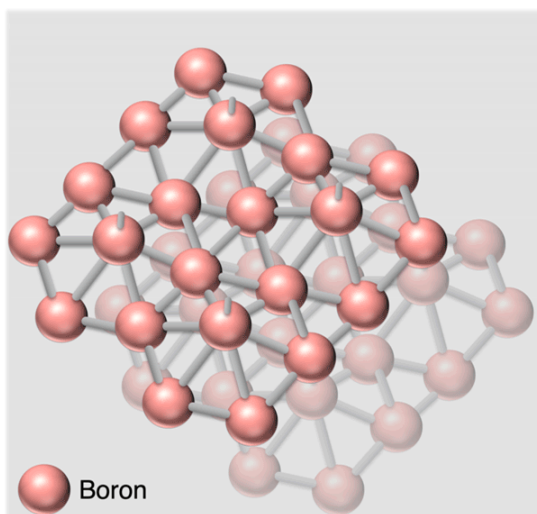

The two-dimensional material borophene, is the boron analogue of graphene

The Northwestern lab made bilayer borophene on a silver substrate through molecular-beam epitaxy [1]

The researchers found that once the surface was covered with single-layer borophene, a second layer would begin to form on top forming bi-layer borophene

Borophene has a theoretical ultimate tensile strength of 13.5 GPa to 22.8 GPa [2]

Borophene can be formed on silver surfaces, however it is highly unstable and oxidises readily, bi-layer borophene does not alter this fact. This means the material will be unstable in the presence of oxygen

Source:

1. Liu, X., Li, Q., Ruan, Q. *et al.* (2021) "Borophene synthesis beyond the single-atomic-layer limit." *Nat. Mater.*
2. Mortazavi, B., Rahaman, O., Dianat, A. and Rabczuk, T., 2016. Mechanical responses of borophene sheets: a first-principles study. *Physical Chemistry Chemical Physics*, 18(39), pp.27405-27413.

Figure 1: Borophene

Figure 1 shows the structure of borophene. The single atomic layer of the material is shown in contrast with the layer below slightly greyed out.

The researchers in the USA made this new material in the laboratory using a technique called molecular beam epitaxy (MBE). MBE sounds like science fiction, in fact it is a well established process used in the semiconductor industry to manufacture electronic devices as thin films of single crystals. Molecular beam refers to the vapour of material used to lay down the layers, it is called a beam because the individual atoms or molecules do not interact with one another as they travel from the source to the destination. Epitaxy for our purposes means making something as a thin single crystal layer on a surface.

The borophene was made in the laboratory using the MBE method to create a bilayer of material on highly polished, pure layer of silver metal. Once the surface was covered with random domains of borophene they found they could grow a second layer on top of the first.

The researchers made enough of the material to explore some of its properties. The team were focussed on the electronic properties of borophene for superconductivity applications. However, the material is inherently unstable in ambient conditions and oxidises readily in air. Bi-layer borophene does not improve the oxidative stability.

This means that borophene will react with oxygen in the Earth's atmosphere and a tether made from this material would rapidly be destroyed. However, this would not be a problem in the vacuum of space, so might we consider this material as a candidate for a Moon or Mars tether?

To answer that question, we need to understand the strength of the material. We know that a tether material has to withstand huge strains. It needs a tensile strength of 60 Gigapascals (GPa) or more.

The researchers in the USA did not make enough borophene to perform these tensile strength tests. However, this work has been done theoretically. A team at the institute of Structural Mechanics, Bauhaus-Universität Weimar, in Germany has calculated the strength of borophene from first principles. They have found that several variations of the 2d structure are possible, and these have ultimate tensile strengths in the range of 13.5 to 22.8 GPa.

So, we can now answer the question "is borophene a candidate tether material?"

The answer is clear. 'No'. Firstly, the material is quite reactive in the presence of oxygen and a tether made from borophene would be destroyed by the Earth's atmosphere. Secondly borophene is not a strong enough material to form a tether. It would snap under the strain.

Having said all that, borophene has now been made in the laboratory and it has moved from the theoretical to the possible. As we develop more technology for the vacuum of space, we should not dismiss materials just because they react with oxygen. There could be myriad uses for novel materials as we become a space faring society enabled by the space elevator.

References:

1. Liu, X., Li, Q., Ruan, Q. et al. (2021) "Borophene synthesis beyond the single-atomic-layer limit." Nat. Mater.
  2. Mortazavi, B., Rahaman, O., Dianat, A. and Rabczuk, T., 2016. Mechanical responses of borophene sheets: a first-principles study. Physical Chemistry Chemical Physics, 18(39), pp.27405-27413.
-

# Tether Materials (September 2022)

by Adrian Nixon, Board Member, ISEC

## Thinking About How to Prevent Slipping in a Layered Tether

In the previous newsletter entry, we introduced the term “Graphene Super-Laminate” (GSL) as the language to use that would describe multiple layers of single crystal graphene, such as that used to make the tether for the space elevator.

We are acquiring more knowledge about GSL as we study its mechanical properties. One aspect we have been studying is how strongly the layers are held together. We know an individual layer of single crystal graphene has covalent bonds that confer an incredibly strong tensile strength (130 GPa) [1].

We also know that the graphene layers in GSL are naturally held together by van der Waals (vdW) bonding and this is much weaker than the covalent bonds. Understanding the strength of the vdW bonding in GSL is important to us. Consider a climber that ascends the tether using opposing wheel pairs with the tether pinched between the wheels. If the van der Waals forces are not strong enough, large shear forces on the tether material will not be sufficiently distributed into the bulk and de-lamination could occur.

We need to understand how the tether will behave under loading as the layers may slip and slide over one another. For this we need to know the shear modulus of GSL. As a result of work done by the climber-tether interface study group we have discovered that the shear modulus of GSL is between 0.19 to 0.49 GPa [2], about 35 times too weak to support a 20-t climber. Thus, another bonding option must be considered.

In GSL, the carbon atoms are connected by hybrid  $sp^2$  bonds. The remaining pi ( $\pi$ ) orbitals are unbonded and oriented perpendicular to the plane of the graphene layer. When two such layers are pressed together with sufficient force, the  $sp^2$  bonds and  $\pi$  orbitals create  $sp^3$  bonds between the layers, as shown in fig 1.

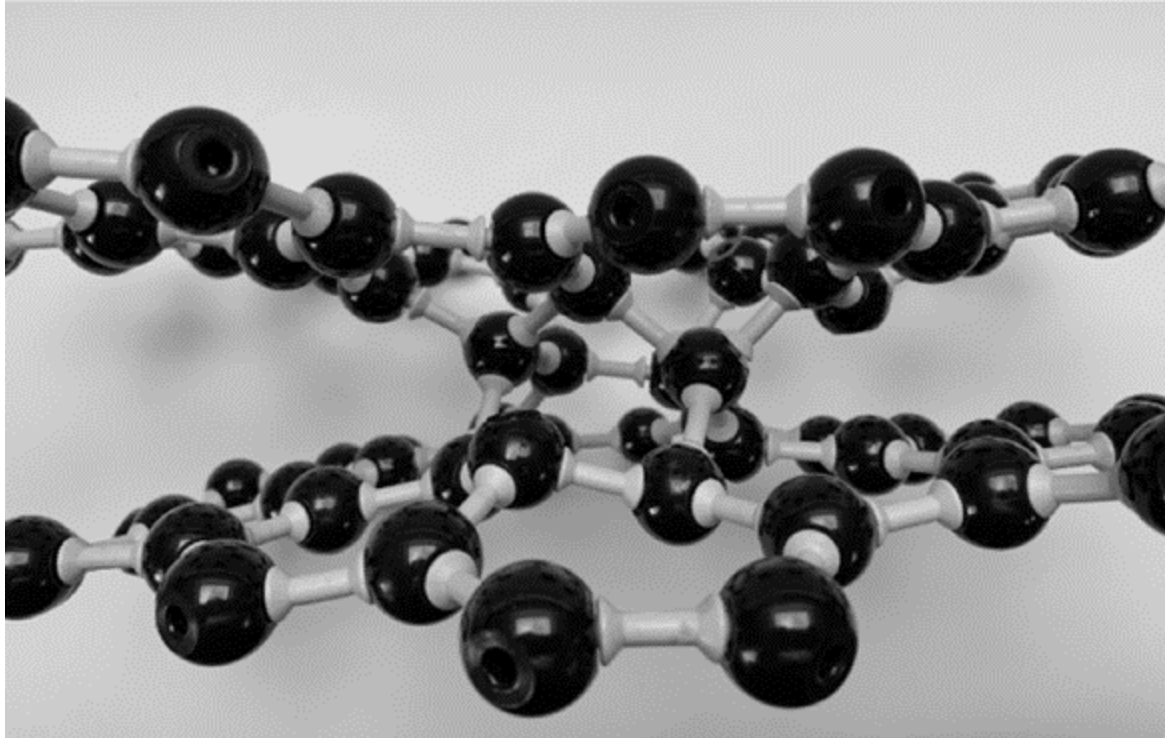

Fig.1: Stick-and-ball model of “spot-welded” multilayer graphene.

The  $sp^3$  hybrid bonds are shown in the center, between two layers of graphene

The  $sp^3$  hybrid bond is the one found in diamond and accounts for its strength. The pressure at which this type of bonding occurs is thought to be about 20 GPa [3]. It has been shown recently that when large numbers of atoms take part in this bonding, the results are irreversible [4]. Perhaps this process could be applied on an industrial scale to produce a material resistant to the shear stresses expected in the space elevator tether.

What all this means is that we may find that layers in a graphene tether may slip and slide over one another as the climber grips the material and pulls itself up and down. We have found a solution in the literature that could give us a mitigation for this problem. This involves creating cross-links between the layers. In effect we can "spot weld" the tether and improve its resistance to slipping under shear.

#### References:

1. Lee, C., Wei, X., Kysar, J. and Hone, J., 2008. Measurement of the Elastic Properties and Intrinsic Strength of Monolayer Graphene. *Science*, 321(5887), pp.385-388.
2. Qu, W., Bagchi, S., Chen, X., Chew, H. and Ke, C., 2019. Bending and interlayer shear moduli of ultrathin boron nitride nanosheet. *Journal of Physics D: Applied Physics*, 52(46), p.465301.



3. Yoshiasa, A., Murai, Y., Ohtaka, O. and Katsura, T., 2003. Detailed Structures of Hexagonal Diamond (lonsdaleite) and Wurtzite-type BN. Japanese Journal of Applied Physics, 42(Part 1, No. 4A), pp.1694-1704.

4. Niu, C., Zhang, J., Zhang, H., Zhao, J., Xia, W., Zeng, Z. and Wang, X., 2022. Configuration stability and electronic properties of diamane with boron and nitrogen dopants. Physical Review B, 105(17).

---

# Tether Materials (August 2022)

by Adrian Nixon, Board Member, ISEC

## Graphene Super-laminate

Veteran readers of the ISEC newsletter will know that we have a good idea what a tether made of graphene will look like. It will be a shiny metallic ribbon a metre wide, 100,000 km long and as thin as Saran wrap (the plastic film used for food wrapping). A tether like this can support seven 20 tonne climbers at evenly spaced intervals.

Multi-layer graphene has the strength to make the space elevator tether

100 million metres long, 1m wide

12,333 layers of  
single crystal graphene  
4 microns thin near Earth

The thickness tapers with the  
maximum at GEO  
(35,786km from Earth's surface)  
being 14 microns

The design can support seven  
20-tonne climbers spaced along it,  
because of the weaker gravity  
at the higher altitudes

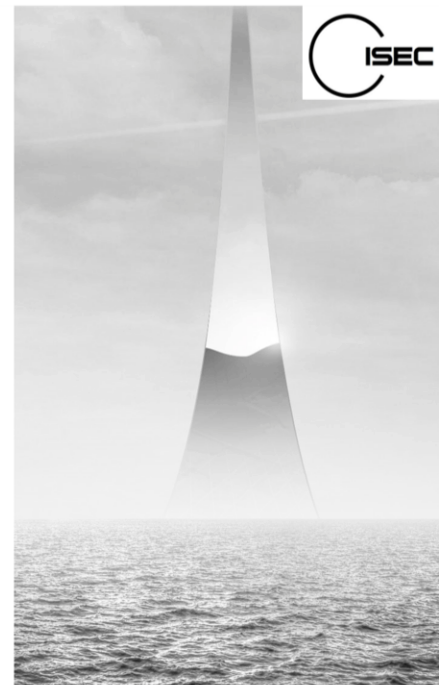
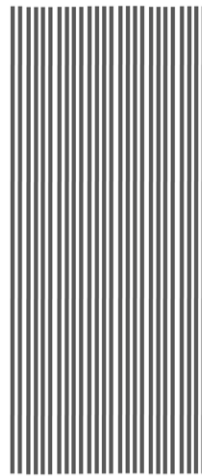

All good so far. However, as we engage with audiences less familiar with this new tether technology, we are encountering misunderstandings that get in the way of communicating the message about the state of the art of graphene manufacturing and its application as a tether material.

### Powders and large-area sheet graphene

When starting to get into the technical detail this is where some confusion can set in. Graphene is made in two forms: powders and large area sheets. Graphene nanoplate powders are being used in a variety of industries from electronics to polymers to concrete. Many people are first encountering this new material as a powder. Large area sheet graphene is the more promising form from the point of view of a candidate material for the tether. You will know from previous newsletter entries just how fast the industrial manufacture of large area sheet graphene is progressing.

## **Crystallinity**

Having made clear that large area sheet graphene is the material of choice, the next step is to address the quality of the graphene. The term crystalline is used. In this context the word crystal means a repeating pattern at the molecular scale rather than the sparkling, brittle material of everyday experience.

Monolayer graphene is made on a growth substrate, usually copper. The metal contains crystal defects that influence the way the graphene layer grows on the surface. Also, when manufacturing graphene as a monolayer the sheet starts to grow from many origins simultaneously. These factors give rise to multiple crystal domains in the monolayer. Where the domains meet crystal grain boundaries and vacancies are created. These defects can weaken the material, and so the ideal for the tether will be to create a sheet of graphene as a continuous single molecule. This is known as single crystal graphene.

## **Multiple layers**

We know from calculations done by the ISEC team that we will need over 12,000 layers of single crystal graphene to make a tether. Layered or stacked structures come in a variety of forms depending how they are made. The current method makes a stack of graphene by separating the graphene from the metal substrate with a bath of etchant solution. This dissolves the metal leaving the graphene floating on the surface of the liquid. The graphene can then be transferred on to another substrate such as a plastic and the process repeated many times to build up a stack on graphene layers on the transfer substrate. The substrate is finally removed leaving a stack of graphene [1].

## **Graphene layers**

A feature of this wet transfer method is that the process contaminates the individual layers of graphene with material from the process such as water vapour and other residues. This prevents the graphene layers from engaging closely and weakens the overall structure.

## **Graphene Van der Waals homostructure**

When the graphene layers are formed without contaminants present each atomic layer can engage with the others. An electrostatic attraction called the Van der Waals (VdW) force helps bond the layers together creating a much stronger structure than would otherwise be expected. This bonding strength increases the rigidity with the cube of the number of layers [1]. Also, a VdW homostructure of single crystal graphene will be much stronger than one made from polycrystalline graphene.

## **Naming convention for describing tether quality graphene**

To describe tether quality graphene in technical terms we will need to name it:

“A Van der Waals homostructure of large-area single-crystal multi-layer graphene”

This clumsy term could invite people to question what the material is. This can lead some people to think: “multilayer graphene – that’s just graphite”. This makes it easy to dismiss this new material without properly thinking through its properties.

In the absence of a technical terminology, we have developed a new naming convention:

- Graphene layers: Graphene that is not a VdW homostructure
- Graphene laminate: A VdW homostructure of polycrystalline graphene
- Graphene super-laminate: A VdW homostructure of single-crystal graphene

## Van der Waals homostructures of graphene: How graphene super-laminate is different to graphite



Graphite  
Multi-layered  
graphene nanoplates



Multilayer graphene exists in nature as graphite  
The bulk material is made of jumbled stacks of nanoplates

Graphene laminate  
Multilayer polycrystalline  
graphene

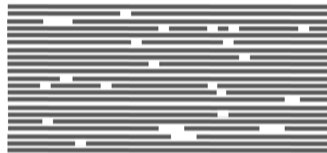

Graphene laminate is an intermediate strength material with many applications but defects restrict its tether application

Graphene super-laminate  
Multilayer single-crystal graphene



Graphene super-laminate is an entirely new material that is not found in nature  
The bulk material is made of highly coherent layered sheets of single molecules of graphene on the scale of centimetres, metres, and ultimately kilometres

Source:  
ISEC Climber-Tether interface study group

These definitions are intended to make it easier to communicate with technical precision the type of multi-layered graphene structures that we will encounter in the coming years, so expect to hear more of these terms, especially graphene super-laminate.

References:

[1] Nixon. A., 2021. The graphene and graphite landscape: Indications of unexplored territory. *Nixene Journal*, 5(10), pp.9-20



# Tether Materials (July 2022)

by Adrian Nixon, Board Member, ISEC

## A New Two-dimensional Material: Graphyne

ISEC members are a smart bunch of people. You scan the literature and often spot interesting developments before I do. My thanks this time to Bert Molloy and Peter Robinson who made me aware that a new allotrope (a new molecular structure) of pure carbon has been made in the laboratory.

Researchers at the University of Colorado, Boulder, USA announced they have successfully made graphyne for the first time [1]. Graphyne is a two-dimensional (2D) material, similar to graphene. It can occur in several forms and its existence has been predicted for over a decade [2].

The team have made  $\gamma$ -graphyne which is the most stable form and is a periodically  $sp$ - $sp^2$ -hybridized carbon allotrope [3]. The following graphic shows the structure.

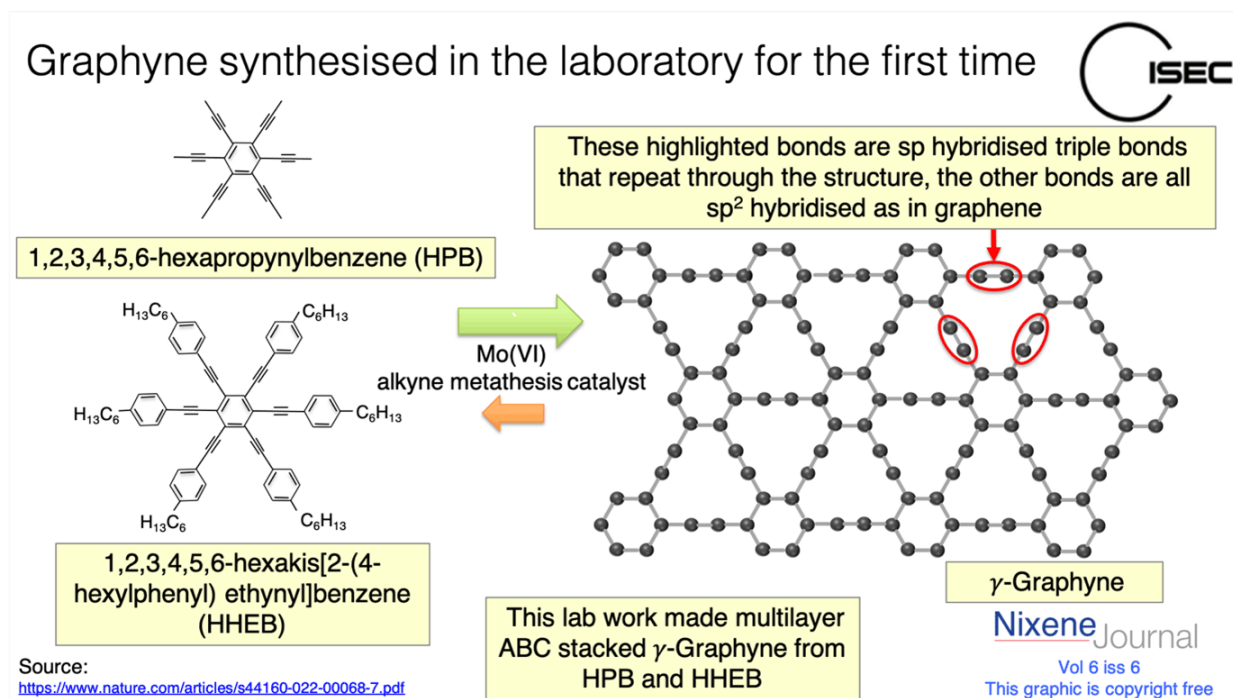

Making graphyne is not easy. The team used a “wet chemistry” approach to make the new molecule from two precursor compounds 1,2,3,4,5,6-hexapropynylbenzene (HPB) and 1,2,3,4,5,6-hexakis [2-(4-hexylphenyl) ethynyl] benzene (HHEB). They used a molybdenum catalyst that enabled a reversible reaction called alkyne metathesis. The reaction was not symmetrically reversible and favoured the creation of graphyne.

The team reported they had made very small flakes of graphyne, around  $10\ \mu\text{m}^2$ . These were enough to be examined and analysed. They found the flakes were made of multilayer  $\gamma$ -graphyne and this was stacked in a repeating ABC sequence.

You will realise that the samples were not big enough to be placed in a tensile testing machine. However, we do know something about the tensile strength from molecular simulations.  $\gamma$ -graphyne is anisotropic. This means its strength depends on whether it is subjected to tensile strength in the x direction or the y direction. Imagine holding a piece of paper in your hands and pulling it apart by holding the top and the bottom or holding it at the sides and you'll get the idea.

In one direction the  $\gamma$ -graphyne molecule is predicted to have a tensile strength of 48 GPa and in the other direction, a tensile strength of 107 GPa [2].

What all this means is that the synthesis of  $\gamma$ -graphyne in the laboratory is an impressive achievement by the team at Boulder, Colorado. However, a wet chemistry approach is more likely to make the material in bulk in the powder form. If the material could be made as very large-scale continuous sheets, then we will have to be very careful how we deploy the material in practise because it has half the strength in one orientation than the other.

Our focus on the 2D material, graphene is still the right one from a practical engineering point of view.

My thanks again to the membership for spotting this development, I am sure you will find many more for me to evaluate as this whole field of 2D materials is moving so rapidly.

References:

1. Hu, Y., Wu, C., Pan, Q., Jin, Y., Lyu, R., Martinez, V., Huang, S., Wu, J., Wayment, L., Clark, N., Raschke, M., Zhao, Y. and Zhang, W., 2022. Synthesis of  $\gamma$ -graphyne using dynamic covalent chemistry. *Nature Synthesis*.
2. Cranford, S. and Buehler, M., 2011. Mechanical properties of graphyne. *Carbon*, 49(13), pp.4111-4121.
3. The terms sp and sp<sup>2</sup> refer to the bond hybridisation in the molecule.

sp refers to a triple bond where the bond angle is  $180^\circ$  so the structure is linear

sp<sup>2</sup> to double bonding where the bond angle is  $120^\circ$  so the structure is trigonal planar

---

# Tether Materials (June 2022)

by Adrian Nixon, Board Member, ISEC

## Carbon Nanotube / Graphene Yarn

My colleagues at ISEC are constantly scanning the research literature for new high strength materials. The latest to appear on the radar is work done by an international team led by the Korea Institute of Science and Technology (KIST) with the Universidad Autónoma de Madrid and Rice University, USA [1].

The team set a goal of making an ultra-strong fibre from carbon nanotubes (CNTs). While CNTs are very strong they can only be made in short lengths. So, this work made a long length of yarn formed from many short CNTs spun and overlapped together. They annealed this at very high temperatures to turn the CNTs into multilayer graphene / graphitic material. The resulting yarn had a tensile strength double that of Kevlar.

The following graphic summarises the new process:

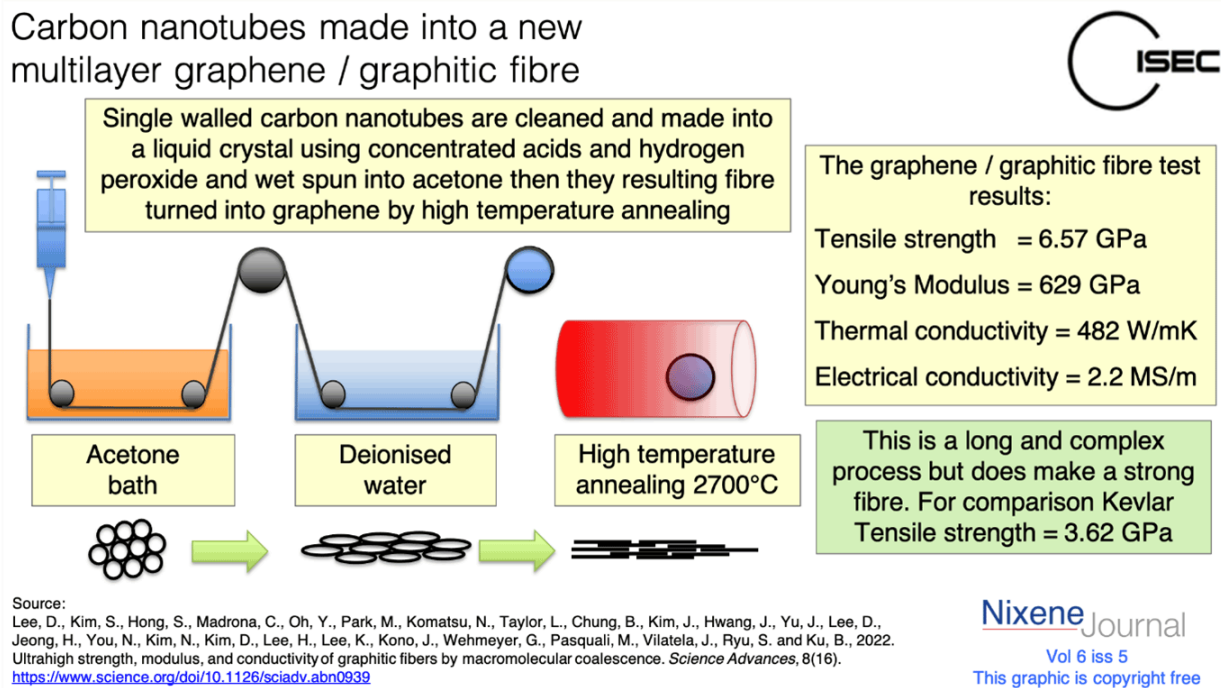

At first sight the new CNT yarn appears to be very strong, with a tensile strength of 6.57 GPa. Kevlar has a tensile strength of 3.62 GPa [2.] The yarn is also electrically and thermally conductive. This means it could have applications as a fibre for making woven ballistic protection (lightweight body armour, for example).

Dear reader, you will have noticed that as impressive as this yarn appears to be, it needs to be an order of magnitude stronger to be considered as a candidate tether material.



If you also look more closely at the way the CNT yarn was made, you will see what is actually happening during the process. The individual carbon nanotubes are being squashed flat. Then the high temperature unzips the nanotubes to form flat sheets of graphene. The team behind this work think that these graphene sheets overlap and crosslink together to a certain extent.

In effect, this process turns carbon nanotubes into a yarn made from layers of polycrystalline graphene nanoplates. This means while we should still be open minded about new materials developments, we should still keep our attention focussed on large-area single-crystal multilayer graphene as the material of choice for the space elevator tether.

#### References:

1. Lee, D., Kim, S., Hong, S., Madrona, C., Oh, Y., Park, M., Komatsu, N., Taylor, L., Chung, B., Kim, J., Hwang, J., Yu, J., Lee, D., Jeong, H., You, N., Kim, N., Kim, D., Lee, H., Lee, K., Kono, J., Wehmeyer, G., Pasquali, M., Vilatela, J., Ryu, S. and Ku, B., 2022. Ultrahigh strength, modulus, and conductivity of graphitic fibers by macromolecular coalescence. *Science Advances*, 8(16).
  2. Anon, 2022. Kevlar Aramid Fibre: technical guide. [online] Dupont.com. Available at: [https://www.dupont.com/content/dam/dupont/amer/us/en/safety/public/documents/en/Kevlar\\_Technical\\_Guide\\_0319.pdf](https://www.dupont.com/content/dam/dupont/amer/us/en/safety/public/documents/en/Kevlar_Technical_Guide_0319.pdf) [Accessed 17 May 2022].
  3. Nixene Journal, 2021. The graphene and graphite landscape: Indications of unexplored territory. [online] 5(10), pp.9-20. Available at: <https://www.nixenepublishing.com/open-access-paper/> [Accessed 11 April 2022].
-

# Tether Materials (May 2022)

by Adrian Nixon, Board Member, ISEC

## How Edge Defects Affect the Tensile Strength of Monolayer Graphene

The lives of people in the future may depend on materials being developing today. So, it will come as no surprise to you that we are paying particular attention to how tether materials behave under stress.

The leading candidate tether material is graphene, one member of a new class of two dimensional (2D) super-strong materials. Graphene is the strongest material in the world because it has a perfect repeating pattern of sp<sup>2</sup> hybridised carbon bonds [1]. However, even the strongest material will fail if the failure conditions are met.

Dear reader, you will probably know that I am part of the ISEC climber-tether interface study group. This is a multi-disciplinary group of scientists and engineers. My role is to cover the materials science of tether materials. One of the concerns, raised in the study group, was that the repeating crystal pattern could unzip and fail catastrophically. One source of critical defects is at the edges of the single-crystal graphene sheet.

Actual laboratory tensile strength testing of single-crystal graphene is hard to find because the material is so new. However, we have found a paper that explores the tensile strength behaviour of graphene with edge defects.

### Edge defects in single-crystal monolayer graphene

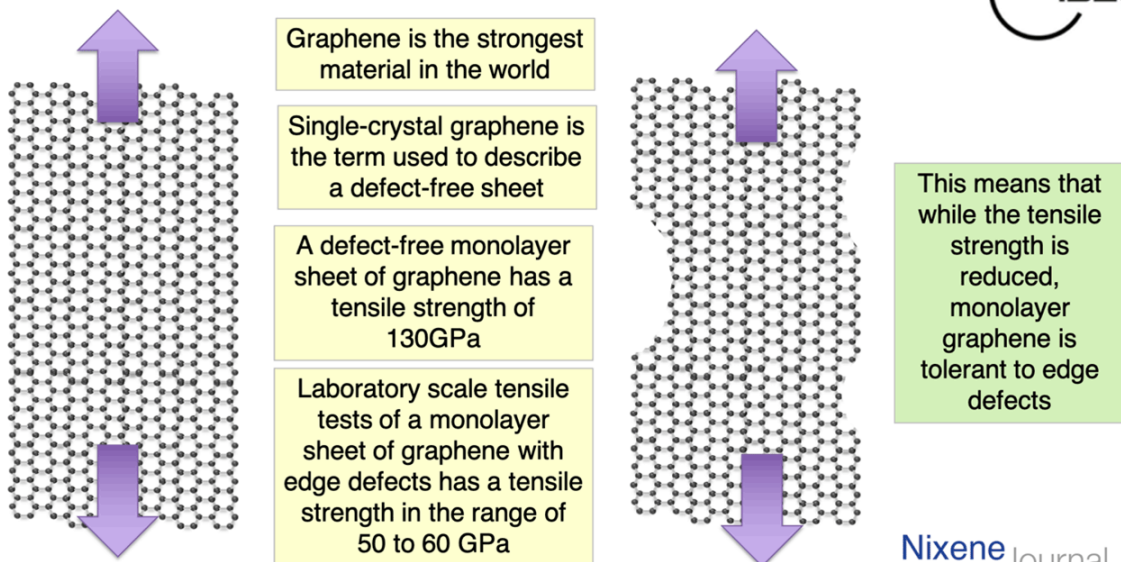

Source:  
Cao, K., Feng, S., Han, Y., Gao, L., Hue Ly, T., Xu, Z. and Lu, Y., 2020. Elastic straining of free-standing monolayer graphene. *Nature Communications*, 11(1). <https://www.nature.com/articles/s41467-019-14130-0>

NixeneJournal  
Vol 6 iss 5  
This graphic is copyright free

This tensile strength testing work was done at the City University of Hong Kong with Tsinghua University, Beijing [2]. They have done tensile strength tests on single crystal monolayer graphene at the micro scale and found the samples have a tensile strength of 50 to 60 GPa. This may seem underwhelming compared with the 130 GPa we expect for single crystal graphene; the team realised that the samples they tested had defects at the edges and this weakened the material.

Even so, these results are still orders of magnitude stronger than anything else tested and shows that defects at the edges do halve the strength of the graphene but not cause the catastrophic strength failure some were anticipating.

The fact the defects retain a lot more strength than we expected and don't seem to unzip probably is encouraging news. It is also worth noting that this work was done on monolayer single crystal graphene and the space elevator tether will be made from tens of thousands of layers of single crystal graphene layered as a Van der Waals (VdW) homostructure.

This means that we have a better understanding of the failure mode of a single layer of tether material and helps us develop many ways to mitigate edge defects, which gives us confidence that we can contribute to preserving the lives of people who travel on the space elevator in the future.

## References

1. Anon, 2022. The Nobel Prize in Physics 2010. [online] NobelPrize.org. Available at: <https://www.nobelprize.org/prizes/physics/2010/illustrated-information/> [Accessed 20 April 2022].
  2. Cao, K., Feng, S., Han, Y., Gao, L., Hue Ly, T., Xu, Z. and Lu, Y., 2020. Elastic straining of free-standing monolayer graphene. *Nature Communications*, 11(1).
-

## Tether Materials (April 2022)

by Adrian Nixon, Board Member, ISEC

### Carbon Nanotubes and Graphene: Part 2: How We Can Know What We-Know-We-Don't-Know

In the last newsletter entry, I compared the progress of manufacturing carbon nanotubes and graphene.

The conclusion was that far more progress is being made on graphene and work on carbon nanotubes has stalled, at least as far as the space elevator is concerned.

The reason for this is that carbon nanotubes can only be made in very short lengths by batch processes.

Graphene is already being manufactured by continuous manufacturing processes. There are at least four competing industrial companies manufacturing graphene right now. The scale and speed of graphene manufacturing is astonishing, graphene can already be made at speeds of up to two metres per minute and in lengths of up to one kilometre.

I was challenged to the effect that this is all very impressive, but could I have missed something? Could there be more work taking place on carbon nanotubes that we could have missed.

How to know what you don't know is always a tricky thing to do. Fortunately, we live in a world of information marvels. Most of the answers are all out there, you just need to know what questions to ask.

The question I asked was "is there a way of finding trends in technologies in published documents over time?"

The answer turns out to be yes, there is. Google has developed a search tool that can show trends with words and phrases over time. Information scientists call these n-grams [1]. Google has developed an n-gram viewer that searched its store of books and pulls out the trend analysis.

So, I ran the analysis comparing the mentions each year of carbon nanotubes and graphene using 1992 as a starting point [2].

## Carbon nanotubes and Graphene: Mentions in published books

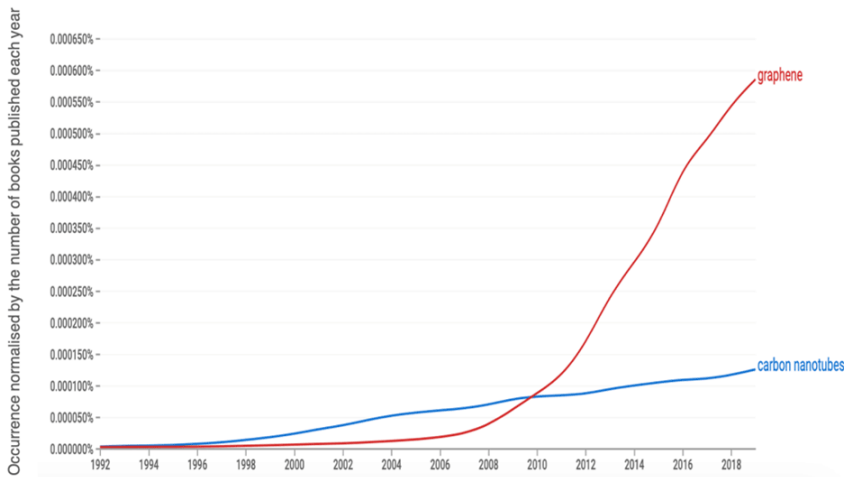

The google n-gram viewer is an online search tool

An n-gram is a contiguous sequence of n-items from a given sequence of text or speech [1]

The chart shows the increased interest in graphene over carbon nanotubes since 2012 [2]

### Sources:

1. Sparavigna, A.C. and Marazzato, R., 2015. Using Google Ngram viewer for scientific referencing and history of science. *arXiv preprint arXiv:1512.01364*.
2. Anon, 2022. *Google Books Ngram Viewer*. [online] Books.google.com. Available at: [https://books.google.com/ngrams/graph?content=carbon+nanotubes%2Cgraphene&year\\_start=1992&year\\_end=2019&corpus=26&smoothing=3](https://books.google.com/ngrams/graph?content=carbon+nanotubes%2Cgraphene&year_start=1992&year_end=2019&corpus=26&smoothing=3) [Accessed 6 March 2022].



The trends of the two materials are revealing. Carbon nanotubes have shown a steadily increasing number of mentions in books over time. However, the interest in graphene has been increasing in the early aughts and since 2010 graphene has been outpacing carbon nanotubes at an ever-increasing rate.

We have gained a small insight into what we-know-we-didn't-know.

The n-gram viewer is not perfect; however, it does give us evidence to state with more confidence that in directing our attention to graphene, we are not missing significant activity in the world of carbon nanotubes. We will keep challenging ourselves though.

### References:

1. Anon, 2022. n-gram - Wikipedia. [online] En.wikipedia.org. Available at: <https://en.wikipedia.org/wiki/N-gram> [Accessed 5 April 2022].
  2. Anon, 2022. *Google Books Ngram Viewer*. [online] Books.google.com. Available at: [https://books.google.com/ngrams/graph?content=carbon+nanotubes%2Cgraphene&year\\_start=1992&year\\_end=2019&corpus=26&smoothing=3](https://books.google.com/ngrams/graph?content=carbon+nanotubes%2Cgraphene&year_start=1992&year_end=2019&corpus=26&smoothing=3) [Accessed 6 March 2022].
-

# Tether Materials (March 2022)

by Adrian Nixon

## Carbon Nanotubes and Graphene

You will recall that NASA calculated that the material for the tether needs to have a tensile strength of at least 62 GPa [1]. There are very few materials that have the required strength. Dear reader, you are part of an informed audience and you will know that there are two classes of materials that are tether candidates: two dimensional (2D) materials and nanotubes.

I was asked recently:

“Why are you so focussed on graphene, what about carbon nanotubes?”

Part of my answer was I am open to considering both materials, it is just that so much more research and development and industrial activity is taking place with graphene and 2D materials that it may appear that I have overlooked carbon nanotubes. I hope I have not. However, it is time to check in on progress with both materials.

### **Material description**

First, a quick recap about graphene and carbon nanotubes. They are allotropes, both are made from the same material—carbon. The atoms are structured in slightly different ways. Graphene is a flat sheet and carbon nanotubes are the same flat sheet rolled up into a seamless tube, hence the nanotube name.

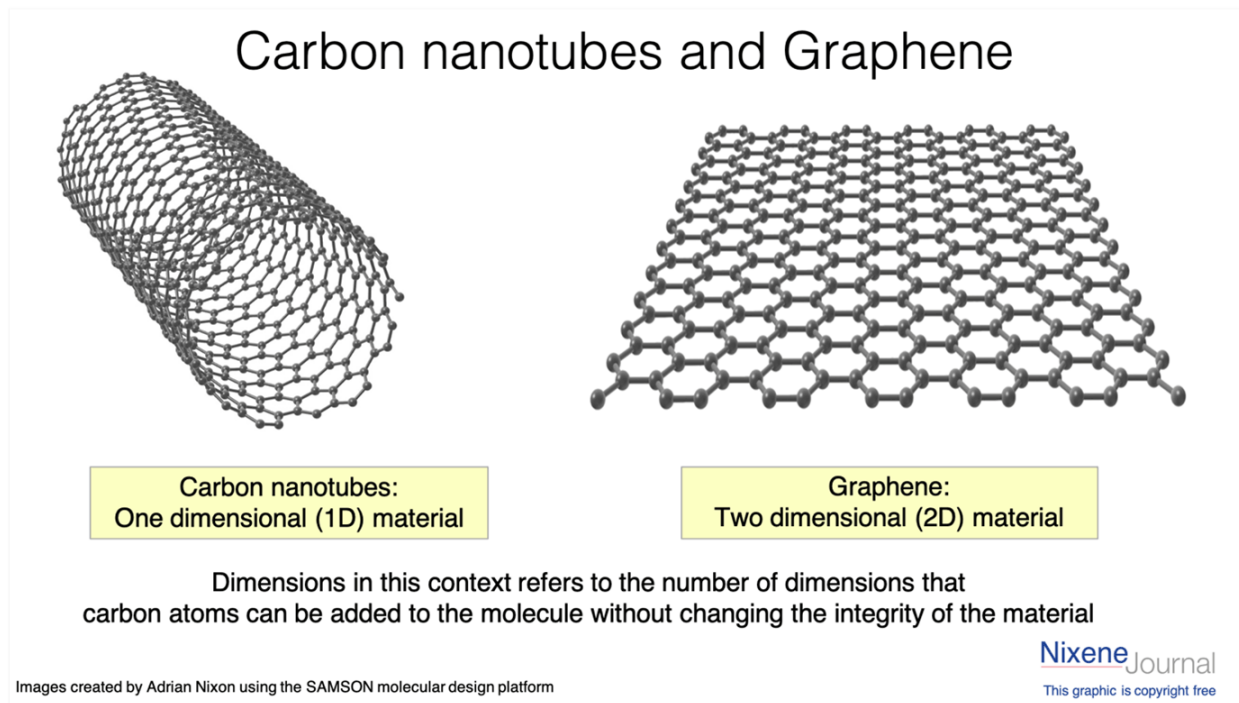

Carbon nanotubes can extend by growing from either end of the tube. This represents just one axis for growth. Graphene can extend by growing from the sides of the sheet and has two axes available for growth. Adding carbon atoms to either material in extra dimensions would change the structure. This is why carbon nanotubes are described as a one-dimensional (1D) material and graphene a two dimensional (2D) material.

Understanding the nature of growth of these materials is vital to understanding the construction of the tether. To take advantage of their strength, the tether must be made from continuous lengths of material. This means each nanotube or flat sheet of graphene is a continuous, defect free molecule stretching from the surface of the Earth all the way up into Space.

This presents challenges that are encountered nowhere else. To think about the details can be overwhelming. So, for the purposes of this article let us concentrate on two aspects of manufacturing: length and speed.

### ***Manufactured Length***

The longest single molecule carbon nanotube that has been made so far is 0.5m in 2013 [2]. Since 2013, no further improvements in length have been reported. The state of the art of carbon nanotube manufacture seems to be to make nanotube forests with a length of 0.14m and probably polycrystalline [3].

Graphene has been made as a single crystal (a single molecule) 0.5m long in 2017 [4]. Since then, industrial scale manufacturing of polycrystalline graphene has been reported at lengths of one kilometre [5].

### ***Speed of Manufacture***

Making material at scale and speed is vital to the successful deployment of the tether. Speeds of metres per second will be required to manufacture the tether in a reasonable timescale.

The latest information available on the average speed of manufacture of carbon nanotubes is that one metre can be made every 278 hours [3].

Graphene can be made on copper foil at speeds of 2 metres every minute [5].

### ***Summary***

To make the material for the space elevator tether requires manufacturing on very large scales and speeds. Carbon nanotubes can be made at sub-metre lengths, very slowly. If a nanotube could be made a metre long, it would take 11 days. Graphene on the other hand can already be made at lengths of one kilometre and a speed of 2 metres per minute. Neither material can be made at tether quality yet, however the trajectory clearly favours graphene as the industrial material of choice.



## **References:**

1. Anon, 2022. Audacious & Outrageous: Space Elevators | Science Mission Directorate. [online] Science.nasa.gov. Available at: <[https://science.nasa.gov/science-news/science-at-nasa/2000/ast07sep\\_1](https://science.nasa.gov/science-news/science-at-nasa/2000/ast07sep_1)> [Accessed 1 March 2022].
  2. Zhang, R., Zhang, Y., Zhang, Q., Xie, H., Qian, W. and Wei, F., 2013. Growth of Half-Meter Long Carbon Nanotubes Based on Schulz–Flory Distribution. *ACS Nano*, 7(7), pp.6156-6161.
  3. Sugime, H., Sato, T., Nakagawa, R., Hayashi, T., Inoue, Y. and Noda, S., 2021. Ultra-long carbon nanotube forest via in situ supplements of iron and aluminum vapor sources. *Carbon*, 172, pp.772-780.
  4. Xu, X., Zhang, Z., Dong, J., Yi, D., Niu, J., Wu, M., Lin, L., Yin, R., Li, M., Zhou, J., Wang, S., Sun, J., Duan, X., Gao, P., Jiang, Y., Wu, X., Peng, H., Ruoff, R., Liu, Z., Yu, D., Wang, E., Ding, F. and Liu, K., 2017. Ultrafast epitaxial growth of metre-sized single-crystal graphene on industrial Cu foil. *Science Bulletin*, 62(15), pp.1074-1080.
  5. Charmgraphene.com. 2021. Graphene on Cu foil. [online] Available at: <[http://charmgraphene.com/bbs/board.php?bo\\_t\\_able=e\\_gp01\\_film&wr\\_id=1](http://charmgraphene.com/bbs/board.php?bo_t_able=e_gp01_film&wr_id=1)> [Accessed 22 July 2021].
-

# Tether Materials (February 2022)

by Adrian Nixon, Board member ISEC

## Quality Control for Large-area Sheet Graphene

Smart people tend to ask the best questions. At ISEC I'm accustomed to working with very smart people.

A while ago I was talking with my ISEC colleague, Michael 'Fitzer' Fitzgerald, about the manufacture of graphene tether material. A tether made of graphene will need to be made of more than 12,000 layers. Each one will be a continuous piece of material as flawless as possible.

In the world of graphene and other two-dimensional (2D) materials, we refer to this flawless quality as a single crystal [1]. A crystal in this context refers to a repeating pattern, the hexagonal molecular unit of graphene, rather than the brittle glittering jewel of our everyday experience.

Fitzer asked me a deceptively straightforward question:

"How do you know when you have made a single crystal?"

That made me think, and at the time I probably gave an inadequate answer. I'll try to do better in this newsletter entry.

To give you some context, let's consider the current state of the art of graphene manufacturing. Graphene can now be made on copper foil by continuous roll-to-roll processes in rolls up to half a metre wide and lengths of hundreds of metres. USA based company; General Graphene has released pictures of the graphene crystals that they can grow at square centimetre scales [2].

### Continuous industrial manufacture of large-scale graphene domains on copper foil

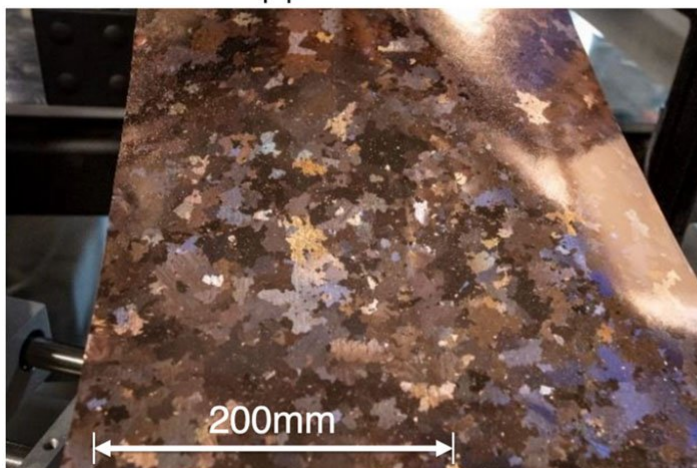

Image Credit: General Graphene

General Graphene GEN 3.0  
Roll to roll (R2R) Chemical Vapour  
Deposition (CVD) graphene  
production line

The picture shows a one atom thin  
layer of polycrystalline graphene on  
copper foil. The pattern shows  
individual crystal domains of graphene

This machine can manufacture  
polycrystalline graphene  
in lengths of hundreds of metres on  
400mm wide copper foil

Production capacity  
100,000 m<sup>2</sup>/year

Source:  
General Graphene: Weir, K., 2021. *Adobe Acrobat*. [online] Documentcloud.adobe.com. Available at:  
<<https://documentcloud.adobe.com/link/track?uri=urn:aaid:scds:US:30e0096c-7694-40ca-a975-27f87d0a0519#pageNum=1>>  
[Accessed 24 October 2021].

Nixene Journal  
Vol 5 iss 11

*Figure 1: Industrial production of polycrystalline graphene with large crystal domains*

Figure 1 shows a single atomic layer of polycrystalline graphene grown on copper foil with individual crystal domains at square centimetre scale.

This poses new challenges for quality control, particularly thinking forward to manufacturing tether quality graphene. The expectation is that these domains are a single crystal of graphene. However, the quality control tests that could prove this still have to be developed. Raman spectroscopy is one of the key tools, but the laser spot size is limited to one micron [3]. This needs to be a thousand times better resolution to reach the nanometre scale.

Electron microscopy can achieve a resolution at the one nanometre level [4], but production samples have to be removed from the roll and analysed offline. Also, a single crystal of graphene would appear as a featureless image at these magnifications, which is hardly ideal for a quality control test.

For the moment, when we look at large area domains of graphene like this, we have to make the assumption that these could be single crystals and accept that no one really knows for sure. However, this is not good enough for the manufacture of tether quality graphene as people's lives will depend on proving the integrity of the material.

For now, we will continue to monitor the research around measurement tools and techniques and influence the development of improved quality control methods.

Fitzer's straightforward question forces us to think hard about the challenge of quality control techniques for tether materials. We will need to be able to measure and prove quality at both the smallest and biggest scales imaginable. At the small end we will need to operate at the nanometre scale, one billionth ( $1 \times 10^{-9}$ ) of a metre, and at extremely large scales, up to one hundred million ( $1 \times 10^8$ ) metres.

This is something we will return to in future newsletters. It is reassuring to know that my colleagues at ISEC are the type of people who have been-there-done-that with seemingly impossible challenges in their careers.

**References:**

1. Nixon, A., Whieldon, R. and Nelson, D., 2021. Graphene: Manufacturing, Applications and Economic Impact. 1st ed. Manchester: Nixene Publishing, p.44.
2. Nixon, A., 2021. Special Feature: Industrial production of large-area monolayer CVD graphene Nixene Journal, 5(11), p.9.
3. Anon, 2022. Raman Imaging & Spectroscopy analysis - HORIBA. [online] Horiba.com. Available at: <[https://www.horiba.com/en\\_en/raman-imaging-and-spectroscopy-analysis/](https://www.horiba.com/en_en/raman-imaging-and-spectroscopy-analysis/)> [Accessed 4 February 2022].

4. Anon, 2011. Introduction to Electron Microscopy - Advanced Microscopy - Imaging Facilities - The University of Utah. [online] Advanced-microscopy.utah.edu. Available at: <https://advanced-microscopy.utah.edu/education/electron-micro/> [Accessed 4 February 2022].
-

# Tether-Climber Interface (December 2021)

by Dennis H. Wright

## Update from the Tether-Climber Interface Study

The ISEC tether-climber interface study is now into its 15th month. The topic of how the space elevator climber will grip the tether and propel itself upward has turned out to be challenging, as expected. We are looking into many aspects of this, that to our knowledge, have never been studied before. These are: understanding the physical conditions that apply where the climber wheels meet the tether surface, how to design a friction-based climber which can lift at least its own weight and how to manufacture a tether composed of 2-D materials that stands up to the shear forces imposed by the climber wheels.

We have coined the term “climbability” to refer to the physical conditions required at the interface to allow climbing. These conditions guide the climber design and prescribe the material parameters that a tether must have. Among these are the coefficient of friction between the climber wheels and the tether surface, the maximum shear stress that the tether can withstand, the minimum pressure that must be applied by the climber wheels to the tether and several more. The study has nearly completed the specification of these conditions and estimates of its parameters.

An examination of the possible tether materials has led us to details of how the tether will be constructed. Our preferred material, single-crystal graphene, has a low coefficient of friction (0.03) and so must be augmented in some way to increase this value. We have outlined ways in which this can be done, each of which seems to be leading us to studies of how macro-molecular sheets can be laminated. This appears to be an issue best studied by computer simulation.

Based on the climbability conditions, our reference design for a tether climber has reached a rather mature state and we are close to producing a mass budget for it. From the outset of the study, we stipulated the use of off-the-shelf technology for the climber. If the climber mass comes in at too high a value, we will need to project which technologies will be able to provide lighter components.

This study has been productive in identifying areas in material science and mechanical engineering that need deeper investigation, and it continues to do so. For this reason, we have already considerably surpassed in length the previous ISEC studies. We expect to complete our work by the Spring of 2022, but as long as fruitful results are forthcoming, we expect the study to continue.

To view his webinar presentation on this subject from the Members-Only meeting that took place August 14, 2021, click [here](#).

---

# **Tether Materials (November 2021)**

*by* Adrian Nixon

## **ISEC Visits the Graphene Engineering Innovation Centre**

As you will know, dear reader, graphene was first isolated in 2004 by two professors at the University of Manchester in the UK. They went on to win the Nobel prize in 2010. Since then, a whole ecosystem of graphene activity has sprung up around the world and its epicentre is Manchester.

From the point of view of graphene there are two significant institutions in Manchester, the National Graphene Institute (NGI) and the Graphene Engineering Innovation Centre (GEIC.) The NGI focusses on early-stage research and the GEIC is more focussed on industrial applications of graphene technology and works closely with industrial partners to develop products of the future.

ISEC was invited to visit the GEIC and we designed a whole day of activities to make the best use of the limited time we had. We were also joined by Steve Foxley (CEO) and Ben Morgan (Director of research) of the Advanced Manufacturing Research Centre (AMRC) based in Sheffield, UK. We were also joined by Prof. Mike Maddock and Rob Whieldon of Nixene Ltd.

The day began with a discussion of graphene and two dimensional (2D) materials in space, followed by a tour of this world class facility. Then in the afternoon we had a series of in-depth discussions about the Green Road to Space, Space elevator technology and the state of the art of graphene manufacturing and future trends.





The Graphene Engineering Innovation Centre, Masdar Building. Image credit: Adrian Nixon.

We were welcomed by James Baker, the CEO of Graphene@Manchester. James has an international reputation and is one of the top people in the world working on industrial applications of graphene and 2D materials.





L-R James Baker, Mike Maddock, Pete Swan, John Knapman. Image credit: Adrian Nixon.

We were joined by academic researchers from the University of Manchester and GEIC staff. The day began with a session on 2D materials applications in space. This was designed as a conversation between informed people rather than presentation / lecture. We explored what 2D materials can do and how they might be applied in space environment.

Then James gave us a tour of the facility starting with an overview of graphene applications. These included electronics, biomedical, water and gas separation and structural applications, many of which are already in production.





James Baker briefing the visitors about graphene industrial applications. L-R Mike Maddock, Ben Morgan, Steve Foxley, Jerry Eddy, Pete Swan, John Knapman, Rob Whieldon, James Baker. Image credit: Adrian Nixon.

The next part of the visit was the Chemical Vapor Deposition (CVD) laboratory.



Dr. Paul Wiper explaining the Aixtron BM Neutron roll-to-roll graphene production line. Note samples of graphene coated copper displayed on the side of the machine. L-R John Knapman, Pete Swan, Steve Foxley, Jerry Eddy, Paul Wiper, Ben Morgan. Image credit: Adrian Nixon.

The GEIC has an Aixtron BM Neutron graphene roll to roll production machine. This is one of only two in the world. The Neutron machine automates the process of creating a precise monolayer of polycrystalline graphene on metal foils.

In the background is another Aixtron batch production line (Novo MOCVD system). This is capable of making atomic layers of different 2D materials. This machine can create stacked 2D heterostructures on circular wafers for the electronics industrial applications.

The manufacturing process for making graphene still has many challenges to overcome before tether quality material can be made. This is the state of the art of graphene manufacturing at present. It is worth reminding ourselves how impressive these machines are. Just 17 years ago in 2004, graphene was thought impossible to isolate as a one atom thin 2D material. The machines you see in this picture are making graphene as a one atom thin 2D material at industrial scale. When you stop and think, this is astonishing progress.



There was so much more to see. James took us to visit the printed electronics laboratory. This is where graphene powders are used to make inks and 3D printed structures.



James Baker with Pete Swan, Jerry Eddy and John Knapman in the printed electronics laboratory. Image credit: Adrian Nixon.





Dr. Vivek Koncherry explaining how waste rubber from automobile tyres can be upcycled with graphene to create new products in the graphene composites laboratory. L-R James Baker, Pete Swan, Mike Maddock, John Knapman, Jerry Eddy, Ben Morgan, Rob Whieldon, Vivek Koncherry. Image credit: Adrian Nixon.

Then finally, to appreciate the industrial scale of activity capable at the GEIC we were given a tour of the High Bay. This is a flexible space where commercial partners create pilot manufacturing lines that bridge the gap between the laboratory and full-scale industrial manufacturing of graphene based products.



L-R Steve Foxley, Mike Maddock, Rob Whieldon, Pete Swan, Adrian Nixon, Ben Morgan, James Baker, Jerry Eddy, John Knapman. Image Credit: Vivek Koncherry.

---



# Tether Materials (October 2021)

by Adrian Nixon

## Industrially Manufactured, Multi-layered, Large-area, Freestanding Sheet Graphene

Industrial manufacturing of sheet graphene is moving astonishingly fast.

Regular readers will recall that in the April 2021 newsletter, I mentioned that General Graphene is the only company in the world who can make polycrystalline sheet graphene at industrial scale and layer it up [1]. This is no longer the case. Another company has made a leap forward in graphene manufacturing technology.

Now, just six months later, Korean company Charmgraphene posted a picture of a proof-of-concept pellicle [2]. A pellicle is a mask transparent to extreme ultra violet light and is used in the manufacture of computer chips.

What is striking about this announcement is that the pellicle is made of multilayer sheet graphene that is freestanding. The sheet graphene is polycrystalline, probably very similar to the material we reported in the April newsletter.

Freestanding means there is no transparent plastic support. What you are looking at in the picture below is large area sheet graphene made of approximately 20 to 30 layers in a metal frame.

### Freestanding multilayer large area CVD graphene pellicle exhibited by Charmgraphene



Extreme Ultra Violet light (EUV) pellicle reported to be made from dozens of layers of graphene  
Dimensions: 110 mm wide and a length of 144 mm  
Image Credit: Charmgraphene [1]

Sources

[1] <https://english.etnews.com/20210802200002> [Accessed 22nd September 2021]

The transparent grey material in the metal frame in the picture is reported to be freestanding multilayer graphene made by Korean company Charmgraphene

The graphene is held in a frame. It is called freestanding because it is not laid on any other support – what you are looking at in this picture is 20 to 30 atomic layers of polycrystalline sheet graphene

A pellicle is a membrane that protects photomasks used in lithography for manufacturing computer chips

The pellicle will dissipate heat when EUV light hits the membrane, temperatures can rise to anywhere between 600 and 1000°C

Graphene is known to be transparent to EUV and has a very high melting point.

This must be freestanding graphene as a plastic support would be destroyed by these temperatures

I'll say that again because this is important: When you look at the transparent grey material in the picture, what you are seeing is large area sheet graphene 20 to 30 atoms thin – and nothing else. The only support is the metal frame around the edges.

We also know that Charmgraphene can manufacture sheet graphene at speeds of 2 metres per minute [3]. They can also transfer the graphene from the copper foil to a transparent plastic support layer. What we now know is that they have developed the technology to take the graphene and build multi-layered material, one atomic layer at a time.

This is important because large-area single-crystal sheet graphene is the leading candidate material for a space elevator tether. The tether would be manufactured by layering up sheets of graphene one atomic layer at a time with no other support material.

While this material is polycrystalline rather than single crystal, this proof-of-concept pellicle shows that large-area sheet graphene can be manufactured and layered up right now.

I hope you agree that when I use the term astonishing progress, this is not hyperbole, it just reflects the pace of development in this fast-moving world of 2D materials manufacturing.

References:

[1] Nixon, A., 2021. ISEC Newsletter, February 2021 edition: Industrially Manufactured Multi-layered Large-scale Sheet Graphene Samples are Sent to ISEC for Testing. [online] Available at: <https://www.isec.org/space-elevator-newsletter-2021-february>

[2] Yun, G., 2021. CHARMGRAPHENE "Development of graphene-based pellicle for EUV... Challenge for commercialization". [online] ETNEWS: Korea IT News. Available at: <https://english.etnews.com/20210802200002> [Accessed 22 September 2021].

[3] Nixon, A., 2021. ISEC Newsletter, August 2021 edition: Latest developments in manufacturing graphene. [online] Available at: Available at: <https://www.isec.org/space-elevator-newsletter-2021-august>

---

# Tether Materials (September 2021)

by Adrian Nixon

## Graphene Manufacturing and Costs Trends

Elon Musk famously stated that “And pls don't ask me about space elevators until someone at least builds a carbon nanotube structure longer than a footbridge” [1]

Elon is still right, no one has been able to make carbon nanotubes longer than a few centimetres. His challenge still stands, the footbridge is still waiting to be made. If we asked him for a view on graphene, he might say something like graphene is too new and expensive.

Dear Reader, as you have been following these newsletter entries, we know things that Mr Musk does not. The two-dimensional material, graphene, is now the leading candidate for the material to make the tether. Monolayer graphene is routinely made by the chemical vapour deposition (CVD) process.

You will recall:

- Graphene is strong enough and light enough to make the tether
- One atom thin graphene can be made by continuous industrial processes
- Graphene can already be made at speeds of 2m per minute
- And graphene can be made in lengths of up to 1 kilometre

So, should someone knock on Elon's door?

The current state of the industry for making graphene still needs some development.

- Graphene needs to be made as a single crystal
  - o Current manufacturing methods make graphene as a polycrystalline material; this means the material contains defects that reduce its strength
- Graphene also needs to be made as a freestanding material
  - o The current state of the art makes polycrystalline graphene on a metal or plastic support

In addition to being made super-fast and super-high quality, graphene also needs to be made cheaply because a space elevator tether needs vast quantities of graphene.

So, how much does it cost to make graphene? It is now possible to answer this question as manufacturers have disclosed some of the numbers involved.



The first reports of graphene manufacturing costs emerged in 2010. The early CVD methods could make graphene in very small areas at very high cost that equated to \$10 million per square metre [3]. Figure 1 shows the manufacturing costs trend. The costs started to decline as the batch manufacturing process was better understood. Then in 2020, manufacturers started to disclose their roll-to-roll processes for the continuous manufacturing of graphene at scale and speed. In 2021 a graphene manufacturing company published their manufacturing costs and we now know that monolayer graphene can be manufactured for just \$7.57 per square metre [4].

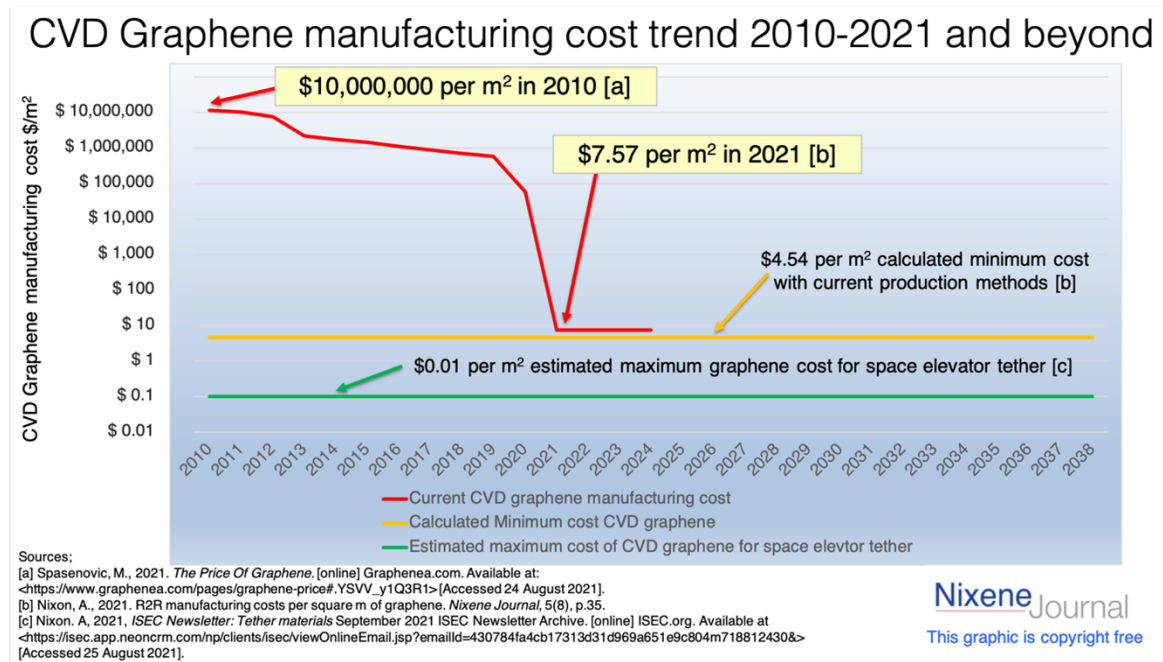

Figure 1. Logarithmic plot of current and future graphene manufacturing costs

Figure 1 also shows the future path for the existing graphene manufacturing technology. Our analysis of the raw material inputs places a lower limit on the cost of \$4.54 per square metre.

CVD graphene is now an industrial material and no longer expensive for many applications.

Thinking from the perspective of the space elevator however forces us to consider material in vast quantities. Consider the tether. This needs to be 100,000 kilometres long and made of at least 12,000 layers of graphene.

Thinking from the space elevator application backwards gives us a different perspective on the manufacturing costs. Graphene will need to be made much cheaper, no more than one cent per square metre (\$0.01 per m<sup>2</sup>) [2].

The existing graphene manufacturing processes have made impressive progress. However, a step change in technology is required to drive down the costs and scale up the production of high-quality large-scale sheet graphene. We are aware of at least one team working on this very problem.

Returning to Elon Musk, he was absolutely correct in his assessment of carbon nanotube technology. However, his team may not be aware of the astonishing pace of development in graphene manufacturing technology. A footbridge-length of single-crystal graphene is still some way off but by the time someone presents him with this material others will have capitalised on the technology and might just have started a new industrial revolution.

#### **References:**

- [1] Musk, E. (2015) [Twitter] 26 January. Available at:  
<<https://twitter.com/elonmusk/status/559557786514632704?lang=en>> [Accessed 25 August 2021]
- [2] Nixon, A. and Swan, P., 2021. ISEC Newsletter Archive. [online] ISEC.org. Available at:  
<<https://www.isec.org/space-elevator-newsletter-2020-december>>.
- [3] Spasenovic, M., 2021. The Price of Graphene. [online] Graphenea.com. Available at:  
<[https://www.graphenea.com/pages/graphene-price#.YSVV\\_y1Q3R1](https://www.graphenea.com/pages/graphene-price#.YSVV_y1Q3R1)> [Accessed 24 August 2021].
- [4] Nixon, A., 2021. R2R manufacturing costs per square m of graphene. Nixene Journal, 5(8), p.35.
-

# Tether Materials (August 2021)

by Adrian Nixon

## Latest Developments in Manufacturing Graphene

Dear Reader, here is a quick recap on graphene manufacturing. Then I'll show you what is happening with the speed of 2D materials manufacturing.

Graphene is currently manufactured in two forms: as powders, and as sheet graphene.

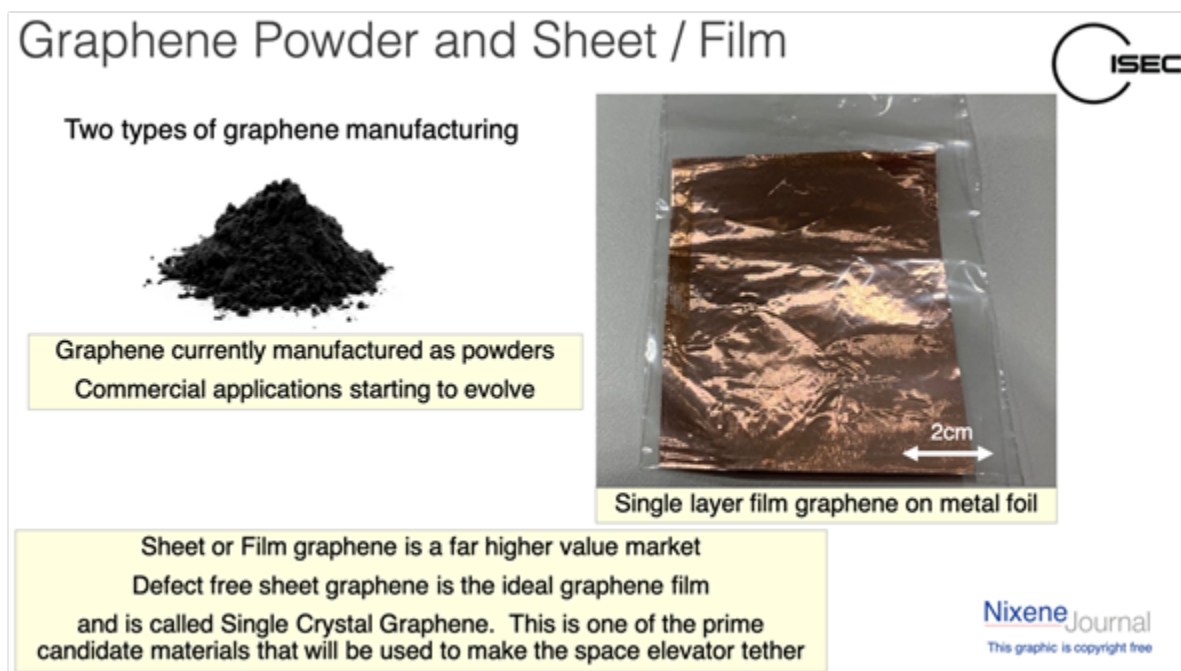

Figure 1. Graphene powder and sheet graphene

Graphene powders are being routinely made at scales of tens and hundreds of tonnes. Industry is now learning how to use the powder form as a performance enhancing additive. It is transforming applications from plastics to concrete to metals.

For the space elevator tether, we need to focus on a more sophisticated form of graphene - Sheet graphene. You can see a one atom thin layer of sheet graphene on the surface of the copper foil in Figure 1 above. If you look carefully at the left-hand side, you will see a darker vertical strip. This is the bare metal. The slightly silvery appearance of the metal, covering most of the surface to the right, is the graphene. You are actually looking at a one atom thin layer of graphene--quite astonishing!

The main method for making large scale sheet graphene is the chemical vapour deposition (CVD) method. The starting point is carbon containing gas such as methane. This is heated to around 1000°C degrees centigrade and blown gently over a metal surface, usually copper or nickel.

The metal acts as a catalyst removing hydrogen from the carbon. The carbon lands on the metal surface and self-assembles, atom-by-atom, to form a layer of graphene. Figure 2 shows how this works.

## Making large scale sheet graphene By Chemical Vapor Deposition (CVD)

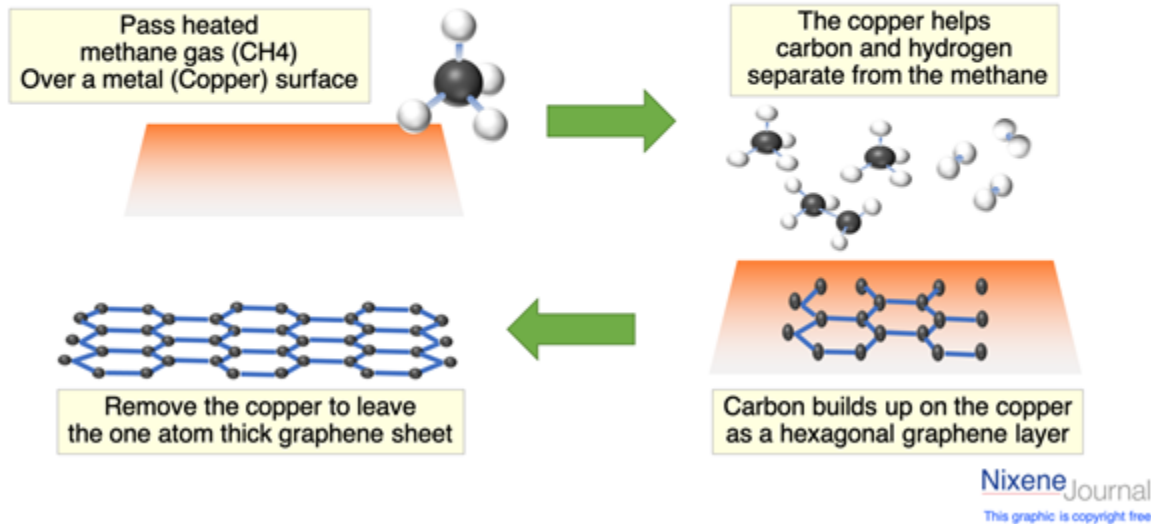

Figure 2. The Chemical Vapour Deposition (CVD) process for making graphene

Once the surface is covered, the metal can be separated leaving the graphene to be transferred to other substrates. A small number of companies, at least one in the USA, are working on scaling up this process to make saleable graphene mainly for electronic device markets at the moment. This process currently makes sheets of polycrystalline graphene (containing defects).

Chinese, Korean and USA researchers have made near-perfect sheets of graphene on metal at square centimetre scale, and these are called single crystal graphene [1].

Companies in the USA and Korea have been working on graphene manufacturing by a continuous process. The current continuous graphene manufacturing process is called roll to roll (R2R) [2]. This is harder to operate and more costly to set up, but once the conditions have been optimised, it can make very large quantities of sheet graphene. Figure 3 shows the basic principles for the R2R process.

## Roll to roll process can make sheet graphene in metre lengths

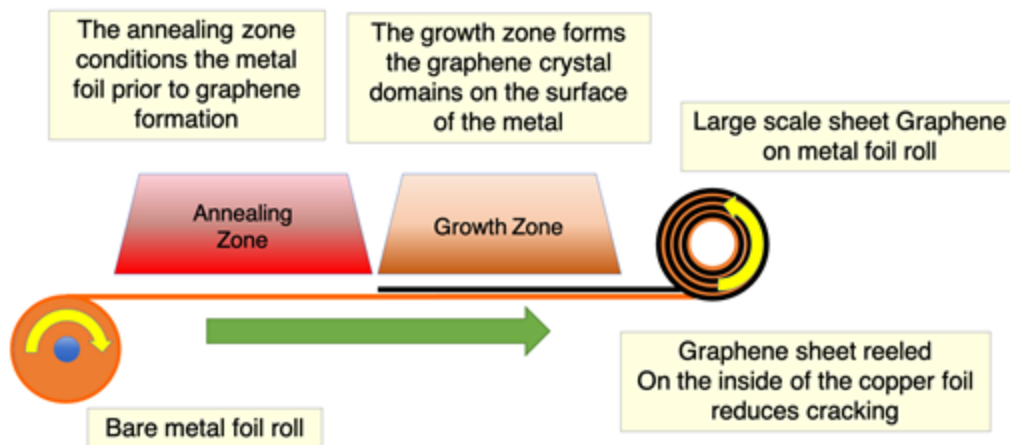

Source:  
<https://pubs.acs.org/doi/abs/10.1021/acsami.8b00846>

Nixene Journal  
This graphic is copyright free

Figure 3. Roll to roll process for making graphene

The continuous process also lends itself to statistical process control techniques that makes a very consistent quality product.

The speed of manufacturing is an important parameter to pay attention to because the space elevator tether is a mega project. The tether has to be made 100,000 km (100 million metres) long and will require 12,000 individual layers.

Early developments of the CVD process in 2014 made graphene at speeds of 0.2m per hour [3].

Last year we discovered that LG electronics has increased the speed of graphene manufacturing to 1m per minute [4].

Now a new manufacturer, Charmgraphene in South Korea has announced they have doubled the speed to 2m per minute [5].

So, we have a ten times rate of increase in speed of the continuous manufacturing process for making graphene over the past seven years, with a doubling in just the last year.

Impressive as these developments are, remember we are working on a mega project. We must keep asking, 'So What ?' every time we encounter impressive statistics.

Even at the fastest speed achievable today, it will take over a hundred years of non-stop production to make one layer of tether. We will need manufacturers to develop production capabilities at least 30 times faster than the best available today to reach speeds of one metre per second. Each layer of tether

will be manufactured in just three years. If we have massively parallel production facilities, we can make the material for a tether in this time.

If this sounds like a big ask, then remember that the industry is already making fragile materials at incredibly fast speeds. The fastest paper machine in the world is at the Zhanjiang Chenming mill in China. During a 24-hour run, the 11.15-metre-wide Valmet PM 1 produced high quality printing paper at a basis weight of 70 g/m<sup>2</sup> and a speed of 1080 metres per minute [6]. That is 30 metres per second (98.4 feet per second).

The engineering exists to make fragile materials at high speeds. If graphene can be made at the speed of a paper machine, then the material for the tether could be made in less than two months.

In one respect, graphene is a simpler process than paper, because it requires fewer raw materials. Graphene also shares a manufacturing step with papermaking. The material is made on one forming surface, then it is separated from that surface and handled at high speeds to be processed as the end product.

The reason for telling you this is that continuous graphene manufacturing for a mega project may seem extremely high tech, but there is a wealth of transferrable industrial engineering and experienced skilled people out there to call upon.

Right now, we are watching the manufacturers competing to make graphene faster than one other. More manufacturers are coming into the open with previously secret projects for making graphene. We can expect to see more. They will increase the speeds and improve the product quality.

Graphene manufacturing is already a reality. The continuous manufacture of tether quality graphene material is still some years into the future. However, making single crystal sheet graphene at scale is not impossible. It is just a series of engineering problems to be solved.

#### **References:**

[1] X. Xu et al. (2017) Ultrafast epitaxial growth of metre-sized single-crystal graphene on industrial Cu foil, *Science Bulletin* 62. 1074-1080

[2] Kidambi, P., et al., 2018. A Scalable Route to Nanoporous Large-Area Atomically Thin Graphene Membranes by Roll-to-Roll Chemical Vapor Deposition and Polymer Support Casting. *ACS Applied Materials & Interfaces*, 10(12), pp.10369-10378.

[3] Ryu, J., et al., 2014. Fast Synthesis of High-Performance Graphene Films by Hydrogen-Free Rapid Thermal Chemical Vapor Deposition. *ACS Nano*, 8(1), pp.950-956.

[4] Kim, Y., LG Electronics, 2020. CVD and Monolayer Graphene Production and Applications [video] Available at: [https://www.youtube.com/watch?v=Oljnh\\_IJRil](https://www.youtube.com/watch?v=Oljnh_IJRil), ( 2:23 to 14:55), [Accessed 21 July 2021].

[5] Graphene-info.com. 2021. CHARMGRAPHENE | Graphene-Info. [online] Available at: <https://www.graphene-info.com/charmgraphene> [Accessed 21 July 2021].

[6] Valmet.com. 2021. The world's best paper machine: UWF speed record of 1,808 m/min. [online]  
Available at: <<https://www.valmet.com/media/articles/all-articles/the-worlds-best-paper-machine-uwf-speed-record-of-1808-mmin/>> [Accessed 21 July 2021].

---



# Tether Materials (July 2021)

by Adrian Nixon

## Fracture Resistance in 2D Materials

New knowledge is being created all the time in the fast-moving field of two dimensional (2D) materials. An international team led by Rice University in the USA has just published new work exploring how 2D materials fail through fracturing [1].

Learning how cracks propagate through tether materials is of real interest for us, so this work got my attention, I'll summarise the academic paper for you...

The team used a combination of computer modelling and experimental observation to explore the nature of crack propagation. They focussed on monolayer single crystal hexagonal boron nitride (hBN) and single crystal monolayer graphene. If you are a regular reader of the ISEC newsletters, you will know these two substances are both prime tether material candidates.

The team was surprised to find that hBN had a much higher fracture resistance than graphene.

### Intrinsic toughening and stable crack propagation in single crystal hexagonal boron nitride (hBN) 'White Graphene'

In hexagonal boron nitride the slight difference in bonds between nitrogen and boron creates a crack with a nitrogen edge and boron edge. The cracks then fragment and branch. This stops cracks propagating throughout the 2D material

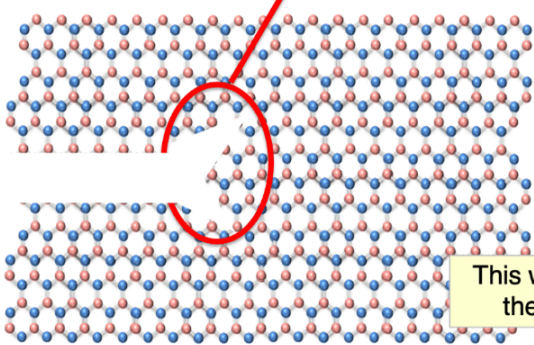

In single crystal graphene all the atoms are exactly the same. Once cracks start they can propagate right through the 2D material

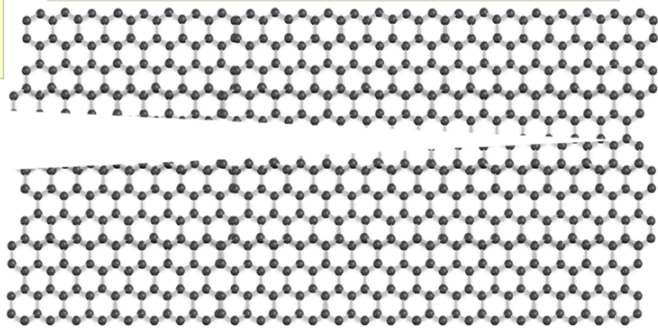

This work shows that hBN has ten times the fracture resistance of graphene

Source:

<https://www.nature.com/articles/s41586-021-03488-1>



Boron (B)



Nitrogen (N)



Carbon (C)

Nixene Journal

Vol 5 iss 7

This graphic is copyright free

The reason for the higher fracture resistance is because hBN is made up of two atoms, Boron and Nitrogen whereas graphene is just one type of atom, carbon. When the tip of a crack propagates through hBN, it continually encounters a boron atom, then a nitrogen atom (or vice versa).



The crack deflection and branching occur repeatedly owing to asymmetric edge elastic properties at the crack tip and edge swapping during crack propagation. The effect of this is to branch and split the crack preventing it from propagating.

The team concluded that hBN has ten times the inherent fracture resistance than graphene. This has implications for using single crystal 2D materials in high mechanical strength applications such as space elevator tether.

Does this mean we should use hBN for the tether rather than graphene? Possibly, although we are exploring how we might modify the layered tether material by bonding layers together and making the structure resistant to cracks and layer slippage. This is easier to do in multi-layered sheet graphene than multi-layered hBN. So, the story still unfolds and we will bring you developments from the edge of material science in future newsletter entries!

**References:**

[1] Yang, Y., Song, Z., Lu, G. et al. Intrinsic toughening and stable crack propagation in hexagonal boron nitride. *Nature* 594, 57–61 (2021). <https://doi.org/10.1038/s41586-021-03488-1>

---

# Tether Materials (June 2021)

by Adrian Nixon

## What Would the Tether Look Like? Part 3: More Evidence from a Graphene Heat Spreader

You'll recall I have been attempting to predict what a tether made from multilayer graphene will look like. I thought it will be silvery and mirror-like (see previous ISEC newsletter entries).[1, 2].

There is a difference of opinion because many academics and industrialists say it will be black, based on their observations of very early multilayer sheet graphene samples.

In my role as editor of the Nixene Journal I get to speak with all sorts of interesting people working in the field of graphene. This month I got a closer view of some new graphene in a meeting with Sixth Element (Changzhou) Co. Ltd. Sixth Element makes heat spreaders from graphene that are used in Huawei smartphones. This is a thin film of graphene that takes heat from the processor and cools the computer chips. The system has no moving parts and doesn't need power to operate. This means the smartphone battery has the potential to last much longer.

These heat spreaders are made from reduced graphene oxide (rGO) nanoplates (essentially a black graphene powder). The rGO is pressed tightly and heated, probably with calendaring. This creates a very thin film of multilayer graphene nanoplates.

Think of this film as highly ordered flat pieces of graphene nanoplates all squished together. This is very similar to polycrystalline sheet graphene, except the nanoplate pieces are not joined by chemical bonds, they just overlap.

I took this photograph of a sample of the multilayer graphene heat spreader on plastic film, about 30 microns thick. The sample is about six centimetres wide and has a metallic, silvery appearance.



Multilayer graphene smartphone heat spreader on plastic film: Image Credit Adrian Nixon

The graphene powder looks black because the nanoplate alignment and voids between them scatter the light. Each atomic layer of graphene absorbs 2.3% of the light that passes through it [3]. Internal reflections within the loose powder absorb more and more of the light and this gives the appearance of a black material.

## Graphene film made from compressed reduced graphene oxide (rGO) powder 30 $\mu\text{m}$ thin has a metallic appearance

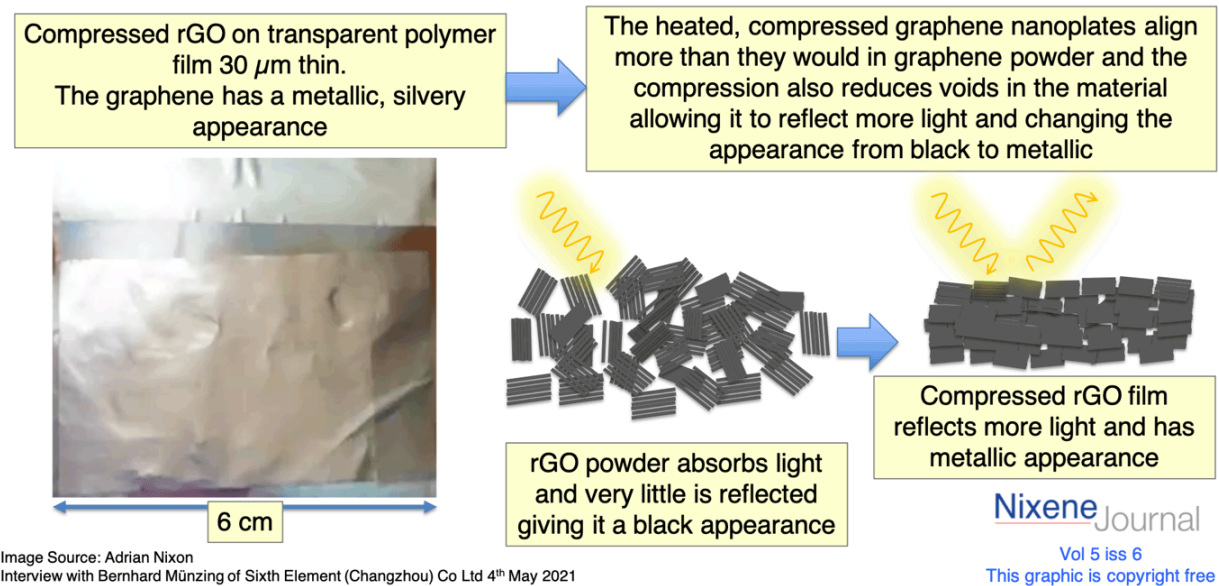

Image Source: Adrian Nixon  
Interview with Bernhard Münzing of Sixth Element (Changzhou) Co Ltd 4<sup>th</sup> May 2021

The pressed graphene film is more ordered than the loose powder and there are more multilayer graphene surfaces aligned in the same direction that reflect the light back. The light is reflected across the visible spectrum and this gives the silvery metallic appearance.

### So, what does all this mean?

The pressed graphene heat spreader film is a good indicator for what a tether made from multilayer graphene would look like. A 30-micron thin film of pressed graphene will contain approximately 50,000 atomic layers of graphene as aligned nanoplates. A tether made from graphene will contain approximately 12,000 atomic layers of large-scale sheet single crystal graphene.

So, we can deduce that the graphene tether would have a similar silvery metallic appearance and because it is formed from flawless multilayer-single-crystal-large-scale-sheet-graphene (which I have modestly dubbed 'Nixene' in the absence of a better term) it would probably have a perfectly shiny mirror-like appearance.

The evidence is stacking up in favour of the hypothesis that the tether material, Nixene, would have a silvery mirror like appearance. We will keep a watch for the evidence both for and against this hypothesis and hopefully entertain you, dear reader in future articles.

### References

[1] Nixon, A., 2021. *ISEC Newsletter, January 2021 edition: What would a tether made from 2D materials look like?*. [online] Available at: <https://www.isec.org/space-elevator-newsletter-2021-february/#tether>

[2] Nixon, A., 2021. *ISEC Newsletter, February 2021 edition: What Would the Tether Look Like? - Part 2: A Tale of Two Tethers*. [online] Available at: <https://www.isec.org/space-elevator-newsletter-2020-december/#tether>

[3] Bonaccorso, F., Sun, Z., Hasan, T. & Ferrari, A. C. 2010. Graphene photonics and optoelectronics. *Nat. Photonics* 4, 611–622.

---

# Tether Materials (May 2021)

by Adrian Nixon

## Space Elevators on Other Planets

Since the first extra-terrestrial planets were discovered in the 1990s [1], astronomy has been adding to the total. At the time of writing, NASA says there are 4375 confirmed exoplanets and counting [2]. The galaxy is a big place with billions of stars, and there are a lot of planets out there.

This raises an interesting question. Given that planets appear to be commonplace with a high probability of earth-like planets out there, why have we seen no evidence of civilisations other than our own? This is the Fermi paradox [3].

The space elevator may offer a different perspective on this question. To address this, I'd like to take you on a journey using graphene materials as a guide from space elevator technology through to the latest developments in astronomy.

First, I need to start with my earlier career as a scientist working in industry...

Some time ago when I worked for a large multinational chemicals company, I was promoted from the laboratory to senior management and became responsible for global market intelligence. This involved gathering information about competitors and customers, then distilling the important market developments and trends for the top decision makers in the company. This is a skill set I still use when editing the Nixene Journal, focusing on the world of graphene and 2D materials.

Over the years, I have noticed how often similar developments appear on the radar at similar times. It is not simply copying. I gradually realised that something more fundamental is at work.

If you think about it, we all operate in a world where the same laws of physics apply. Given a specific problem, it is hardly surprising that different groups of people come up with very similar solutions. Appropriately enough, others have thought about this phenomenon. It is called multiple discovery or simultaneous invention [4].

Consider the problem of escaping the gravity well of a planet. We have settled on rocketry for the last half century. However, once we need to scale up the transport of mass from the surface of the planet to space, the limitations of rocketry become increasingly apparent. It takes a lot of propellant mass to take a small payload mass to orbit. This is known as the rocket equation and was again developed independently by at least two people; Konstantin Tsiolkovsky (1903) and Robert Goddard (1912) [5].

A complementary technology needs to be developed to get us out of the gravity well of our planet. This is the space elevator. One of the key components of this technology is the tether. Regular readers will know that the leading tether candidate material is a form of carbon called multilayer single crystal graphene. Sheet graphene is now being produced in industrial quantities and has reached the point

where we can seriously consider the manufacture of tether quality sheet graphene within the decade [6].

So, we are faced with a defined set of problems and defined palette of materials operating in a defined physical environment.

Any planet-bound, extra-terrestrial civilisation faces the same problem. As far as we can tell, they will also be constrained by the same physical laws as we have [7]. This means an alien culture with the intent to leave the confines of their planet may well have developed space elevator technology.

So, we have a hypothesis. The space elevator technology may have been invented multiple times by civilisations on other planets. The next question is, how might we know if this is true? To answer this, we need to be able to see what is going on out there. Observing the universe is the province of astronomy, and the field has some interesting new developments that may help this quest.

A new form of astronomy is emerging using the terahertz (THz) part of the electromagnetic spectrum. In just a few years, the number of active THz researchers has substantially grown, due to increased interest in terrestrial remote sensing at THz frequencies [8].

Graphene has the potential to revolutionise THz spectroscopy, because it can make very sensitive and low power THz sensors which would be ideal for space-based THz telescopes [9].

Graphene has many other properties. It is highly reflective in the THz region of the spectrum [10], and we know that stars like our Sun are natural sources of THz radiation [11]. Graphene is also a very stable material and lasts a long time. Some researchers have deduced that the closely related graphite could be among the oldest materials in the universe [12].

So, what does all this mean?

We have a hypothesis that extra-terrestrial civilisations could have already invented space elevator technology, because they are faced with the same problems and have the same physics, chemistry and engineering toolkit available to create solutions. A planet with one or more space elevator tethers will be spinning and orbiting its star. The tethers are reflective particularly in the THz region of the spectrum and will shine with flashes of reflected light for any observer who may be watching.

One of the arguments used to explain the Fermi paradox is that civilisations tend not to last a long time, and this is why we have seen no evidence of life elsewhere. We know that graphene lasts a very long time, and it is possible that if a culture develops a graphene space elevator tether, it could outlast its creators.

THz astronomy has begun, and graphene technology will accelerate the development of this field. When astronomers of the future train their telescopes on planets orbiting distant stars, they may be puzzled to see lighthouse-like flashes of light. These flashes just might be the reflected light from space elevator tethers developed by civilisations other than ours. Time will tell.

## References

- [1] E-education.psu.edu. 2021. The Search for Planets around Other Stars | Astronomy 801: Planets, Stars, Galaxies, and the Universe. [online] Available at: <[https://www.e-education.psu.edu/astro801/content/l12\\_p3.html](https://www.e-education.psu.edu/astro801/content/l12_p3.html)> [Accessed 14 April 2021].
- [2] Exoplanet Exploration: Planets Beyond our Solar System. 2021. Exoplanet Exploration: Planets Beyond our Solar System. [online] Available at: <<https://exoplanets.nasa.gov>> [Accessed 14 April 2021].
- [3] En.wikipedia.org. 2021. Fermi paradox - Wikipedia. [online] Available at: <[https://en.wikipedia.org/wiki/Fermi\\_paradox](https://en.wikipedia.org/wiki/Fermi_paradox)> [Accessed 14 April 2021].
- [4] Merton, R., 1963. Resistance to the Systematic Study of Multiple Discoveries in Science. *European Journal of Sociology*, 4(2), pp.237-282. < <https://www.cambridge.org/core/journals/european-journal-of-sociology-archives-europeennes-de-sociologie/article/abs/resistance-to-the-systematic-study-of-multiple-discoveries-in-science/8FEC108B3D8B0DAD60416B36BE342959> > [Accessed 14 April 2021]
- [5] En.wikipedia.org. 2021. Tsiolkovsky rocket equation - Wikipedia. [online] Available at: < [https://en.wikipedia.org/wiki/Tsiolkovsky\\_rocket\\_equation](https://en.wikipedia.org/wiki/Tsiolkovsky_rocket_equation) > [Accessed 14 April 2021].
- [6] Nixon, A., Whieldon, R. and Nelson, D., 2021. Graphene: Manufacturing, Applications and Economic Impact. 1st ed. Manchester: Nixene Publishing, pp.21-26.
- [7] Davies, P., 1993. The mind of God. New York: Penguin.
- [8] Walker, C., 2019. TERAHERTZ ASTRONOMY. Boca Raton, Florida: Routledge.
- [9] Chalmers.se. 2021. Graphene detector can revolutionize space telescopes | Chalmers. [online] Available at: <<https://www.chalmers.se/en/departments/mc2/news/Pages/Graphene-sets-the-stage-for-the-next-generation-of-THz-astronomy-detectors.aspx>> [Accessed 14 April 2021].
- [10] Santos, C.N. et al. 2016. Terahertz and mid-infrared reflectance of epitaxial graphene. *Scientific Reports*, 6(1).
- [11] Trottet, G. et al. 2015. Origin of the 30 THz Emission Detected During the Solar Flare on 2012 March 13 at 17:20 UT. *Solar Physics*, 290(10), pp.2809-2826.
- [12] Hazen, R.M, 2013. Carbon Mineral Evolution Reviews in Mineralogy and Geochemistry. 75(1), pp 79-107
-



# Tether Materials (April 2021)

by Adrian Nixon

## Industrially Manufactured Multi-layered Large-scale Sheet Graphene Samples are Sent to ISEC for Testing

In the last newsletter entry, I mentioned that a graphene manufacturer had been in touch. That manufacturer was General Graphene, based in Knoxville Tennessee, USA.

Right now, General Graphene is the only company in the world that can make polycrystalline sheet graphene at industrial scale and layer it up.

They have been in touch again and this time they have sent the first samples of industrially manufactured graphene to ISEC. Michael (Fitzer) Fitzgerald and Dennis Wright have the samples.

Fitzer took these pictures, we thought you'd like to see this too:

### Manufacturing of large-scale sheet polycrystalline graphene The first look at test samples from General Graphene



Monolayer and multilayer graphene samples on polyethylene terephthalate (PET) film

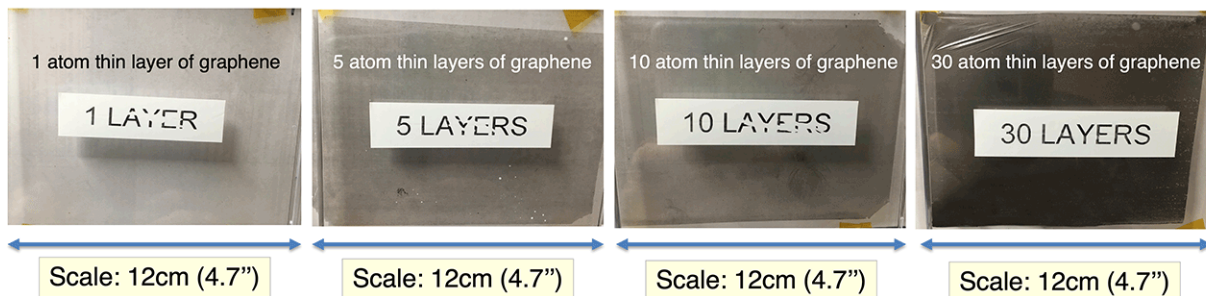

General Graphene has developed the manufacturing process

- They can make large-scale polycrystalline sheet graphene at metre scales
- They can also separate the graphene from the metal forming foil
- They can transfer graphene to plastic support substrates
- They can build up atom thin graphene layers

Note:  
This is not tether quality.  
It does show the fast  
pace of industrial  
graphene manufacturing  
development

Image credit: Michael (Fitzer) Fitzgerald. International Space Elevator Consortium (ISEC)

What General Graphene have just done was impossible just 17 years ago.

This is graphene industrially manufactured a large scale, separated from its forming substrate and then stacked one atom thin layer at a time on a target substrate.

This is not tether quality graphene, it is polycrystalline and the tether will require single crystal graphene.

You will also notice some tears and breaks in the samples. Remember this material is just thirty atoms thin. It is a testament to the strength of graphene that the material can be handled even now.

While these samples might seem fragile right now, single crystal graphene will be even stronger and when it is layered up in thousands of atomic layers it will become virtually indestructible.

When I presented to ISEC in Seattle in 2018, this industrial material was still theoretical. You are now seeing it for real for the first time.

This demonstrates the astonishing pace of change taking place in the world of graphene and 2D materials

This is why we say graphene has gone from impossible to industrial in 17 years.

Expect more to come...

---

# Tether Materials (February 2021)

by Adrian Nixon

## What Would the Tether Look Like? Part 2: A Tale of Two Tethers

I made a prediction that a Space Elevator tether created from multi-layered single crystal graphene would look metallic and probably mirror-like.

A graphene manufacturer has been in touch. They are one of the few companies in the world that can make polycrystalline sheet graphene and layer it up. They told me that as they increase the number of layers of their graphene it looks to them progressively black, not mirror like.

So, we have a tale of two tethers, will a graphene tether look metallic and mirror-like or will it look black?

I will admit to disappointment contemplating this empirical observation from industry experts. But then I dived back into the literature to find out more...

A colleague at the International Space Elevator Consortium (ISEC) pointed me in the direction of a paper from 2010 that I had not seen [1]. This observed the optical reflection and transmission properties of graphite from a graphene monolayer to several hundred graphene layers. They focused their attention on a 35-layer sample.

### Optical reflection of 35 layer graphene derived from graphite

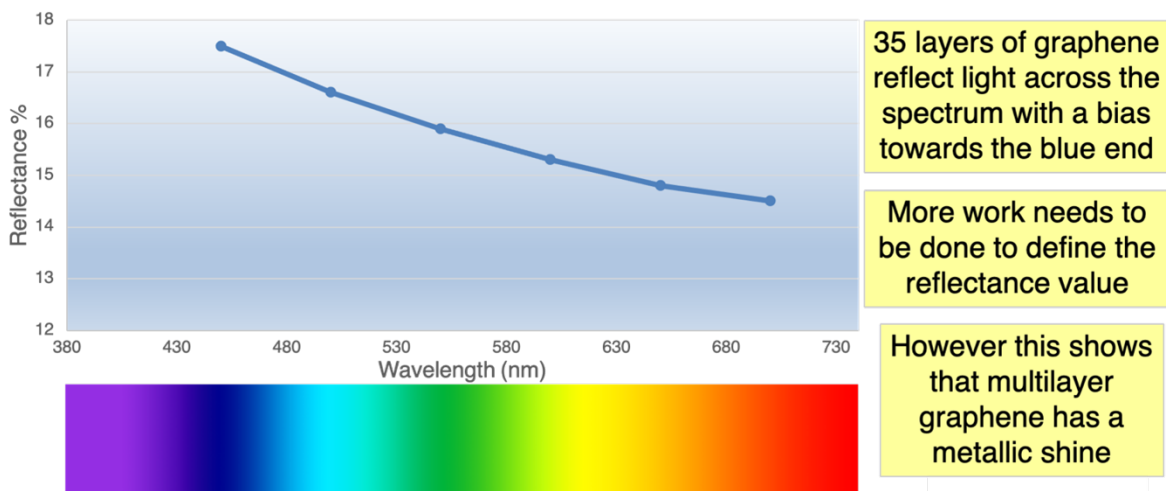

Source: Skulason, H. et al. (2010) Optical reflection and transmission properties of exfoliated graphite from a graphene monolayer to several hundred graphene layers <https://iopscience.iop.org/article/10.1088/0957-4484/21/29/295709>

Nixene Journal  
January 2021  
This graphic is copyright free

This work is one of very few that is based on experimental data. The team from McGill University in Montreal, Canada, isolated 35 layers of graphene from graphite. This is a very small-scale representation of what multilayer single crystal graphene will look like in visible light.

The team found that the multilayer graphene reflected light across the visible part of the spectrum with a tendency towards the blue end of the spectrum. This means that the bulk material such as the tether will have a silvery metallic appearance with a slight bluish hue.

Then another colleague made me aware of a discovery by the Manitoba Mineral Society in Canada. The society has identified an unlabelled exhibit in a Canadian museum as an exceptional example of graphite crystals ten to fifteen centimetres in scale.



World-class graphite crystals in standing sheets 10 to 15 cm high. Thanks to the Manitoba Mineral Society for pointing out these unlabeled specimens from Baffin Island, on display at the Canadian Museum of Nature, Ottawa, Canada. Image credit: Mike Beauregard from Nunavut, Canada. [2]

If this discovery is confirmed by Raman spectroscopy, you are looking at a material that contains the largest crystals of graphite ever found. This will be a very good guide to the appearance of a tether made from multilayer single crystal graphene.

So, we have a tale of two tethers. On the one hand we have information telling us that multilayer graphene will be black. On the other, we have alternative evidence showing it will be metallic silvery, possibly with a blue tint.

Neither pieces of evidence are definitive at present. However, I'll stay with my original prediction that the space elevator tether will be silvery, metallic and mirror-like.

## What would a graphene Space Elevator tether look like?



A tether would need to be made of tens of thousands of layers of single crystal graphene

We know from the molecular structure that graphene has a shiny metalling appearance

Multilayer single crystal graphene 'nixene' would look like a glittering sliver mirror stretching from the surface of the earth and vanishing into the sky

NixeneJournal



Image credit:  
Michael Hiraeth  
Pixabay

Time will tell which is correct.

### References:

[1] Skulason, H., Gaskell, P. and Szkopek, T., 2010. Optical reflection and transmission properties of exfoliated graphite from a graphene monolayer to several hundred graphene layers. *Nanotechnology*, 21(29), p.295709.

[2] File:Kimmirut Graphite.jpg - Wikimedia

Commons [https://commons.wikimedia.org/wiki/File:Kimmirut\\_Graphite.jpg](https://commons.wikimedia.org/wiki/File:Kimmirut_Graphite.jpg) [accessed 20th January 2021]

---

## News from the GEIC (December 2020)

by Adrian Nixon

### What Would a Tether Made from 2D Materials Look Like?

At the time of writing there are three potential materials that are light enough and strong enough to make the tether for the space elevator. Carbon nanotubes, Graphene and hexagonal Boron Nitride.

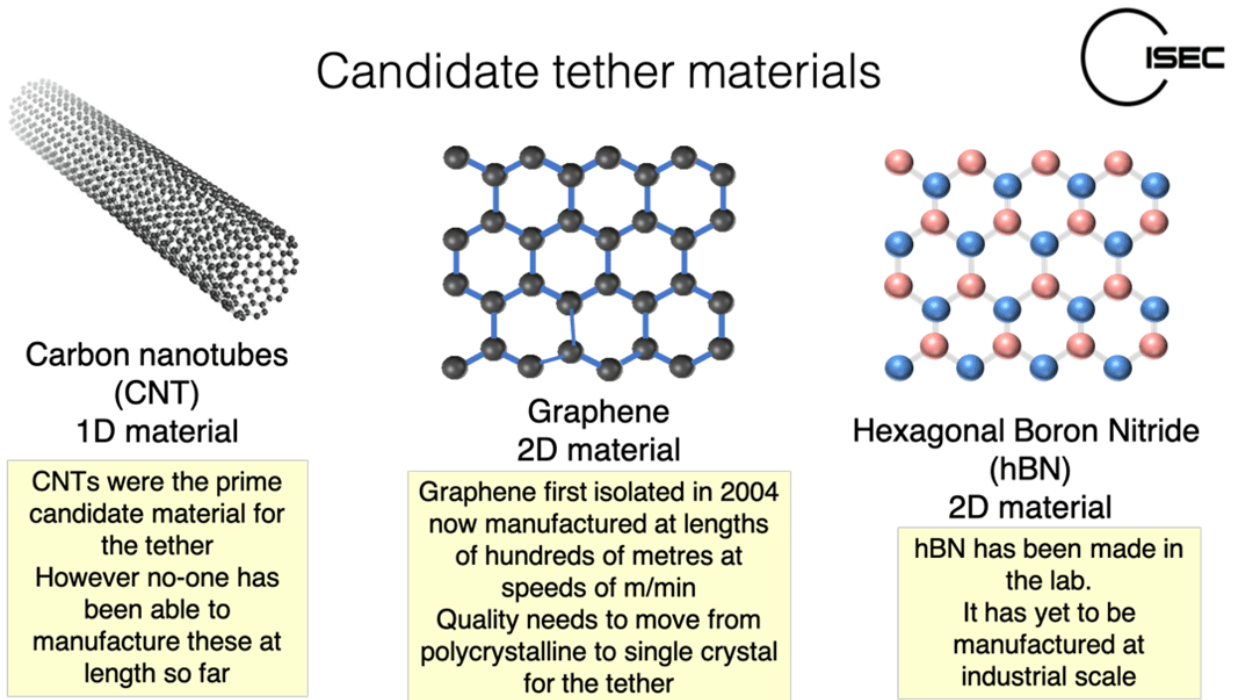

Of the three-candidate materials graphene is emerging as the most likely at present because the industrial manufacturing process has advanced rapidly. Graphene can now be made at industrial lengths and speeds. The quality is not good enough for a tether at the moment but given the pace of manufacturing progress this can now be considered a credible future material.

A graphene tether has yet to be made for real so we need to look at the molecular structure of graphene.



# The source of graphene's properties



The electron cloud above and below each carbon ring overlaps creating a continuous pi ( $\pi$ ) orbital across the whole graphene layer. This is what makes graphene so highly conductive and also metal-like.

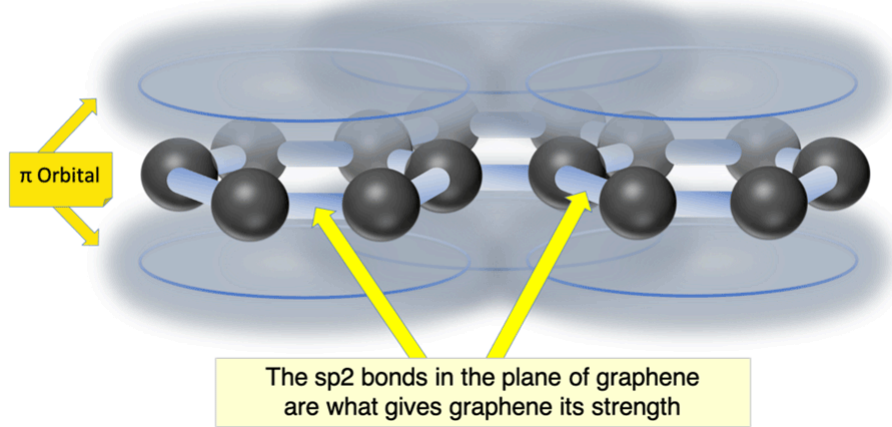

[Note: This paragraph corrects an error in the emailed version of the newsletter.] We know that graphene has an electron cloud called a pi ( $\pi$ ) orbital above and below the plane of the rings. When photons arrive at this surface, they encounter the electrons. Some absorb these photons promoting the electrons to a higher energy level. When the electrons drop back down to a lower energy level, the photons are re-emitted, and this is what creates the characteristic metallic appearance.

## Graphene Mirrors



**Properties:**  
 Very high melting point  
 Chemically stable surface.  
 A very hard material.  
 Unlikely to be ductile.

Multi-layered Nixene (CVD graphene) will make extremely light and thermally stable mirrors

Multilayer graphene  
 Looks metallic.  
 Electrically conductive.  
 and is mirror-like

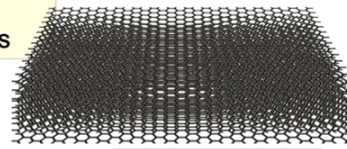

Polycrystalline graphene and single crystal graphene

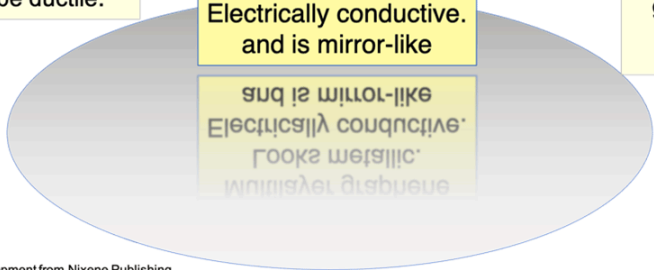

Predicted technology development from Nixene Publishing

Nixene Journal  
 October 2020  
 This graphic is copyright free

This means bulk, multi-layered graphene will look like a shiny metallic mirror. This bulk material is what will be used to make the space elevator tether.



## What would a graphene Space Elevator tether look like?



A tether would need to be made of tens of thousands of layers of single crystal graphene

We know from the molecular structure that graphene has a shiny metalling appearance

Multilayer single crystal graphene 'nixene' would look like a glittering sliver mirror stretching from the surface of the earth and vanishing into the sky

[Nixene](#)Journal



Image credit:  
Michael Hiraeth  
Pixabay

So, to answer the question posed at the start, a space elevator tether would look like a glittering sliver mirror ascending into the sky piercing the clouds to reach for space.

---

## **News from the GEIC (March 2020)**

*by* Adrian Nixon

### **The Graphene Engineering Innovation Centre**

(GEIC, pronounced like 'geek')

This is an extract from the journal about the [Orbex space company](#) with their graphene enhanced carbon fibre launch vehicle.

Date: 19/01/20

Headline:

Britain's Third Rocket Company Names Its First U.S. Customer

<https://www.foo.com/Investing/2020/01/19/britains-third-rocket-company-names-its-first-us-c.aspx>

<https://orbex.space>

Content summary:

- Orbex is a UK-based private, low-cost orbital launch services company, founded in 2015
- It has developed what it calls an "advanced, low carbon, high performance micro-launch" rocket dubbed "Orbex Prime,"

<b>MARKET</b>
Aerospace
<b>APPLICATION</b>
Composites - polymer
<b>PRODUCT TYPE</b>
Graphene nanoplate



Image courtesy of Orbex

- Orbex Prime is built with 3-D-printed engines and a carbon fibre -and-graphene body, Orbex Prime will utilize renewable "bio-propane" as its fuel of choice. The two-stage rocket will be designed to carry up to 150 kilograms of payload, contained within a 1.3-meter fairing, into Sun Synchronous Orbit.

Relevance:

- Orbex is a relatively new space company.
- The graphene enhanced carbon fibre is used in the main structural components
- It is also used for the tanks which are filled with liquid propane gas
- This makes technical sense because graphene can improve carbon fibre composites in several ways:
  - Increasing the strength (by 30% enabling lightweighting)
  - Increasing the impact resistance (increasing failure tolerance)
  - Reducing the porosity (keeping fuel contained) (also reducing moisture absorption – lightweighting and widening the launch window for weather conditions)

## News from the GEIC (February 2020)

by Adrian Nixon

That's the coolest business card I've seen...

That's what the journalist said who interviewed us at the GEIC, in the UK.

I'm with James Baker, CEO of the Graphene Engineering Innovation Centre (GEIC, pronounced like 'geek') in Manchester, UK. The GEIC is where academia and industry meet to test and develop exciting new applications and products made with the wonder material, graphene. Some of the world's top scientists work here. It's an exciting place to be.



Adrian Nixon in the boardroom at the GEIC.

James and I were being interviewed for a podcast by award winning journalist Tom Whalley, he came straight from the British Broadcasting Corporation (BBC) to visit us at the GEIC. As well as producing programmes for the BBC he also has a high-profile podcast that speaks to people in the world of cycling.

Now at this point you may be thinking cycling? Bear with me. It turns out that the world of cycling is really big business, particularly in Europe but also around the world. The professionals and serious amateurs are really into their tech. The cycling world is one of the early adopters of graphene technology. The athletes have realised that graphene makes the difference between winning and

losing. Graphene rubber composites are in the bike tyres. All the time trial winners of the major races won on graphene tyres. Tom was interviewing James and Me to find out what else graphene can do. So, we dived in with a double act and rather impressed him with what we see coming out of the labs and into real world products.

Then, towards the end of the interview Tom said, "I've heard that graphene can do something for the Space Elevator, can you tell me about that?" That really surprised me, Tom is one of the more remarkable and well-informed journalists.

So, I told Tom how the Space Elevator works. He now knows that all the components for the Space Elevator are do-able with today's technology. The remaining problem is to find a material strong enough and long enough to make the tether. Then I told him about the process we have proposed to make graphene in continuous sheets. The space elevator is closer than people think. "Wow! That's definitely going to make the cut," he said.

Oh, and the coolest business card? Normally people say that when they meet James Baker. This time it was mine:

Adrian Nixon  
Member, Board of Directors  
The International Space Elevator Consortium

It's good to be reminded when I have my head down in my work that I'm doing really cool and fun stuff with impressive people these days!

---